

AMC Visiotherm & Audiotherm

DE	Gebrauchsanleitung	2
EN	User Manual	15
IT	Istruzioni per l'uso	28
ES	Manual de instrucciones	41
FR	Notice d'utilisation	54
NL	Gebruiksaanwijzing	67
HR	Uputa za uporabu	80
SI	Navodila za uporabo	93
SK	Návod na používanie	106
TK	Kullanım kılavuzu	119

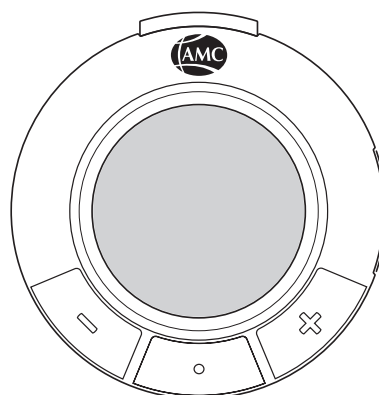

Eat better.
Live better.

The Premium Cooking System.
www.amc.info

AMC Visiotherm & Audiotherm

Gebrauchsanleitung

Inhalt

1. Visiotherm	
1.1 Bestimmungsgemäße Verwendung und Sicherheit	4
1.1.1 Geeignete Deckel	4
1.1.2 Sicherheit	4
1.2 Aufbau und Anzeige	4
1.3 Montage und Inbetriebnahme	5
1.4 Pflege und Reinigung	5
2. Audiotherm	
2.1 Bestimmungsgemäße Verwendung und Sicherheit	5
2.2 Inbetriebnahme des Audiotherm und Batteriewechsel	6
2.3 Aufbau und Display	7
2.3.1 Aufbau	7
2.3.2 Display	7
2.4 Funktionen	8
2.4.1 Aufsetzen auf Visiotherm	8
2.4.2 Einschalten	8
2.4.3 Zeit einstellen	9
2.4.4 Zeitkontrolliertes Gratiniere und Backen	10
2.4.5 Küchenwecker einstellen	11
2.4.6 Signalton abschalten	12
2.4.7 Audiotherm von Visiotherm abnehmen	12
2.4.8 Audiotherm ausschalten	12
2.5 Zusätzliche Funktionen	12
2.5.1 Ton ändern	12
2.5.2 Modus für Menschen mit Sehbehinderung	13
2.5.3 Software und Hardware anzeigen	13
3. Was ist zu tun, wenn ...	13
4. Pflege und Reinigung	14
5. Audiotherm und App	14
6. Entsorgung	14
7. Technische Daten	14
8. Konformitätserklärung	14
9. AMC Kundenservice	14

Visiotherm und Audiotherm sind ausschließlich für den haushaltsüblichen und bestimmungsgemäßen Gebrauch bestimmt. Bei unsachgemäßer Verwendung können Gefahren entstehen.

Bitte lesen Sie die Gebrauchsanleitung – insbesondere die Hinweise zur bestimmungsgemäßen Verwendung und Sicherheit – aufmerksam durch, bevor Sie Visiotherm und Audiotherm verwenden. Bewahren Sie die Gebrauchsanleitung auf und geben Sie sie an NachbesitzerInnen weiter.

Lesen Sie zudem bitte auch die Broschüre „Kochen mit AMC“ und zugehörige Gebrauchsanleitungen der mitverwendeten AMC Produkte aufmerksam durch.

Bedeutung der Symbole



Für die Sicherheit wichtige Anweisungen. Nichtbeachtung kann zu Verletzungen oder Schäden führen.



Schlechter Betriebszustand oder unsachgemäße Verwendung.



Guter Betriebszustand oder sachgemäße Verwendung.



Nützliche Anwenderhinweise.



Hinweise zu Umweltschutz, Ökologie und Ökonomie.



Arbeitsschritte sind mit einem Pfeil hervorgehoben.

Version der Gebrauchsanleitung für Visiotherm und Audiotherm: 07/2020

1. Visiotherm

Visiotherm auf AMC Deckeln misst die Temperatur in Topf und Pfanne und zeigt sie im Display an. Visiotherm zeigt so optisch, ob im Topf oder in der Pfanne die gewünschte Temperatur vorliegt.

1.1 Bestimmungsgemäße Verwendung und Sicherheit

1.1.1 Geeignete Deckel

Visiotherm ist für alle Deckel von AMC Töpfen und Pfannen geeignet.



1.1.2 Sicherheit

- Gefahren durch Hitze beachten, heiße Deckel nur am Visiotherm anfassen.
- Visiotherm ist mit einem Magneten zur Übertragung der Temperatur ausgerüstet. Ein Herzschrittmacher kann in den Testmodus geschaltet werden und Unwohlsein verursachen, wenn er sich in weniger als 2 cm Abstand zum Sichtfenster des Visiotherm befindet.
- Kreditkarten, EC-Karten, Datenträger, Hörgeräte oder mechanische Uhren können beeinträchtigt werden, wenn sie sich in weniger als 2 cm Abstand zum Sichtfenster des Visiotherm befinden
- Visiotherm nicht im Backofen oder in der Mikrowelle benutzen.

1.2 Aufbau und Anzeige

- | | |
|---|----------------------------|
| 1 | Zeiger |
| 2 | Brat-Fenster |
| 3 | Wendepunkt |
| 4 | Gemüse-Fenster |
| 5 | Temperaturbereich „Gemüse“ |
| 6 | Stopp-Fenster |

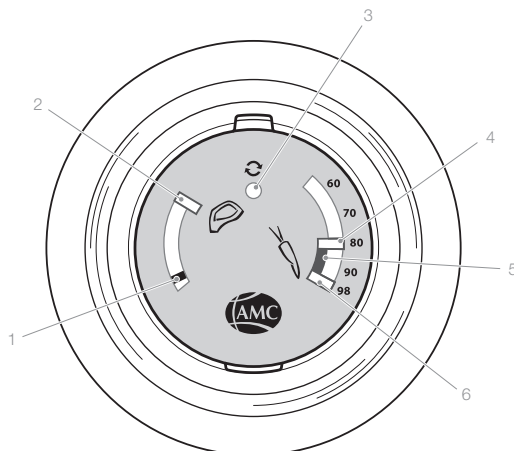

Beachten Sie die Beschreibungen und Tipps in der Broschüre „Kochen mit AMC“.

1.3 Montage und Inbetriebnahme

- ➔ Visiotherm vor der ersten Inbetriebnahme mit einem feuchten Tuch abwischen.
- ➔ Visiotherm auf den Deckel schrauben.

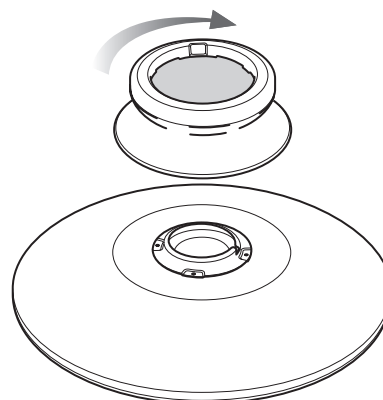

1.4 Pflege und Reinigung

- ➔ Visiotherm vom Deckel abschrauben und beides in der Spülmaschine oder von Hand reinigen.
- ➔ Für die Spülmaschine haushaltsübliche Maschinenreiniger verwenden.
- ➔ Bei Reinigung von Hand Spültuch oder weichen Schwamm sowie neutrales Spülmittel verwenden.



2. Audiotherm

2.1 Bestimmungsgemäße Verwendung und Sicherheit

Audiotherm überwacht zusammen mit Visiotherm den Kochvorgang. Audiotherm zeigt die vom Visiotherm im Topf gemessene Temperatur an und dient als akustische Temperatur- und Kochzeitüberwachung sowie als Steuerung beim kontrollierten Kochen mit dem Navigenio.

Geeignete Deckel

- Deckel mit Visiotherm
- Dampfgardeckel EasyQuick mit Visiotherm E
- Schnellkochdeckel „Secuquick softline“ mit Visiotherm S



Beschädigungen und unsachgemäße Verwendung vermeiden.

- Audiotherm nicht im Backofen oder in der Mikrowelle benutzen und keinen Temperaturen über 70 °C aussetzen.
- Audiotherm nie in Wasser tauchen oder in den Geschirrspüler geben.
- Audiotherm dient zum Überwachen oder Steuern des Kochvorgangs. Audiotherm nur für diesen Zweck verwenden. Bei einer unsachgemäßen Verwendung können Gefahren entstehen.
- Audiotherm enthält Batterien. Batterien dürfen nicht in die Hände von Kindern gelangen, da sie verschluckt werden können.
- Nur Batterien empfohlener und gleichwertiger Art (gemäß Kapitel 5) verwenden.
- Nicht versuchen, nicht wiederaufladbare Batterien aufzuladen.

Beachten Sie bitte auch die Gebrauchsanleitungen von EasyQuick, Secuquick softline und Navigenio sowie die Hinweise und Tipps in der Broschüre „Kochen mit AMC“.



Beaufsichtigung

- Der Kochvorgang muss beaufsichtigt werden. Zur akustischen Überwachung des Kochvorgangs Audiotherm nur in Hörweite verwenden.
- Unbeaufsichtigtes, unkontrolliertes Kochen kann zu Überhitzung führen. Speisen können verderben und der Topf kann beschädigt oder zerstört werden. Unfall- und Brandgefahr.
- Das Gerät kann von Kindern ab 8 Jahren oder Personen mit eingeschränkten physischen, sensorischen oder geistigen Fähigkeiten bzw. Mangel an Erfahrung oder Wissen benutzt werden. Sie müssen jedoch beaufsichtigt oder bezüglich des sicheren Gebrauchs des Geräts unterwiesen werden und die daraus resultierenden Gefahren verstanden haben. Dies betrifft auch die akustische Überwachung durch Sehbehinderte (siehe Kapitel 2.5.2).

2.2 Inbetriebnahme des Audiotherm und Batteriewechsel

Inbetriebnahme:

Im Lieferumfang des Audiotherm sind zwei Batterien enthalten (Typ gemäß Kapitel 5). Batterien zur Inbetriebnahme einlegen.

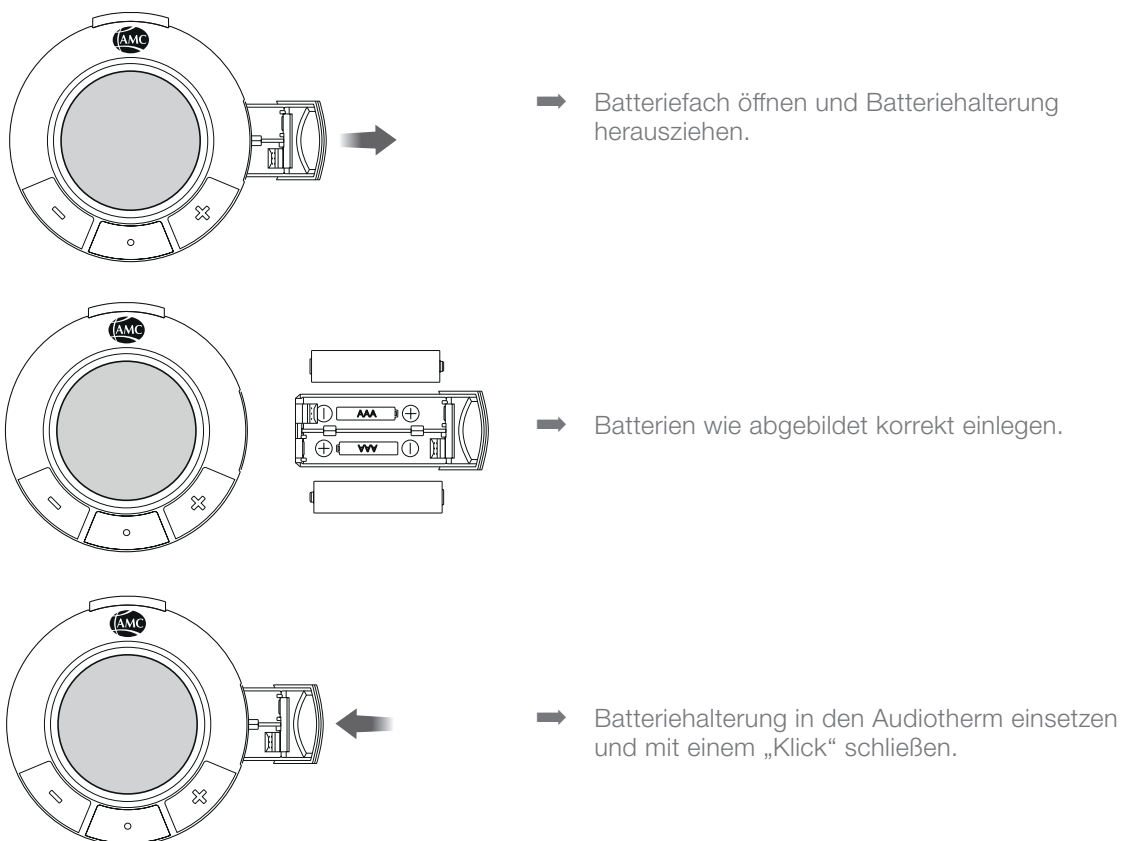

Batteriewechsel:

Ist im Display die Batterieanzeige sichtbar, Batterien zeitnah wechseln.



Verbrauchte Batterien entsprechend den örtlichen Vorschriften entsorgen!

2.3 Aufbau und Display

2.3.1 Aufbau

- 1 Entsperrtaste
- 2 **-**-Taste
- 3 Mittlere Taste
- 4 **+**-Taste

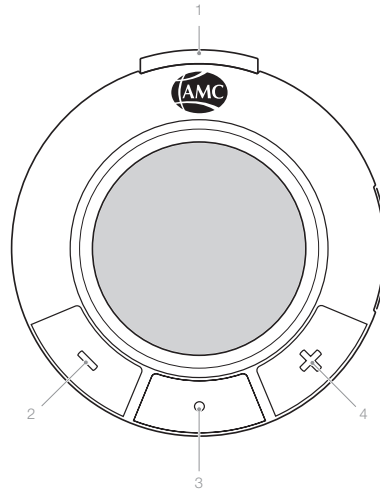

2.3.2. Display

- 1 Soft-Symbol
- 2 Brat-Symbol
- 3 Gemüse-Symbol
- 4 Basis-Linie
- 5 Symbol „Wendepunkt“
- 6 Wendepunkt
- 7 Dampf-Symbol
- 8 60 °C-Symbol
- 9 Minus-Anzeige

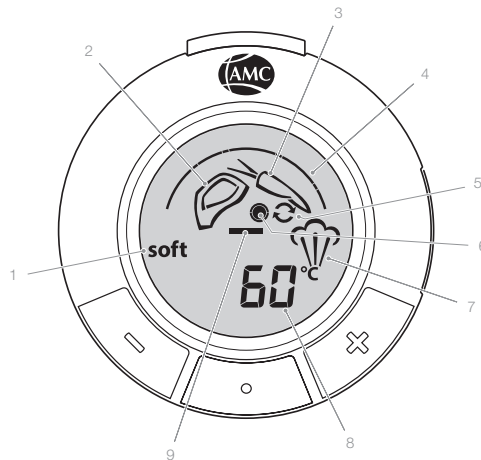

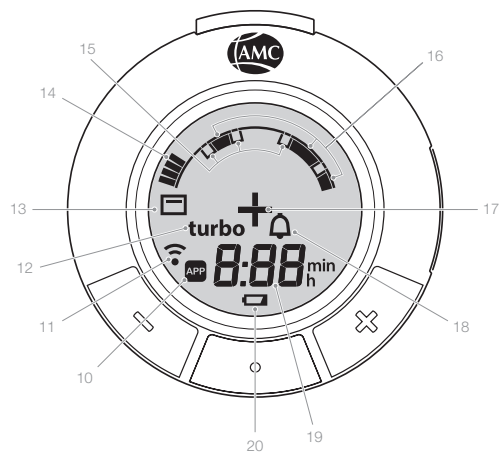

- 10 Verbindung „App“
- 11 Verbindung „Navigenio“
- 12 Turbo-Symbol
- 13 Back-Symbol
- 14 Temperaturskala
- 15 Aktionspunkte
- 16 Temperaturbereiche
- 17 Plus-Anzeige
- 18 Küchenwecker-Symbol
- 19 Zeitanzeige
- 20 Batterieanzeige



2.4 Funktionen

Das AMC Kochsystem umfasst verschiedene Kochmethoden. Audiotherm kann dabei auf zweierlei Weise eingesetzt werden.

Manuelles Kochen mit Visiotherm und Audiotherm:

- Audiotherm zeigt die aktuelle Temperatur an und weist mit Signaltönen  darauf hin, wenn etwas zu tun ist. Er zeigt im Display an, was zu tun ist.
- Audiotherm weist mit einem Signalton  darauf hin, dass die Kochzeit abgelaufen ist.
- Die Bedienung der Kochstelle wird vom Anwender vorgenommen.

Kontrolliertes Kochen:

Beim Kochen auf der mobilen Kochplatte „Navigenio“ ermöglicht Audiotherm das kontrollierte Kochen.

- Audiotherm kontrolliert über eine Funkverbindung mit Navigenio den gesamten Kochvorgang selbstständig.
- Nach dem Einschalten des Navigenio auf „A“ wird die Bedienung des Navigenio durch den Audiotherm übernommen.
- Audiotherm weist mit einem Signalton  darauf hin, dass die eingegebene Kochzeit abgelaufen ist.



Alle Kochfunktionen (Ausnahme: geplantes Kochen und 60 °C-Programm) können sowohl manuell als auch kontrolliert erfolgen.

Beachten Sie die Beschreibungen und Tipps in „Kochen mit AMC“.

2.4.1 Aufsetzen auf Visiotherm

- ➔ Audiotherm mit dem Druckknopf nach oben gerichtet auf Visiotherm aufsetzen und mit einem „Klick“ einrasten lassen.

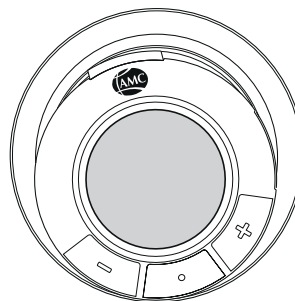

2.4.2 Einschalten

- ➔ Eine beliebige Taste drücken.

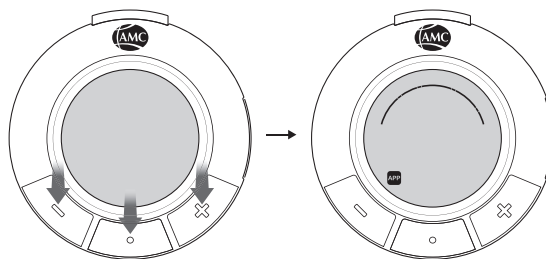

2.4.3 Zeit einstellen



Zeiten können eingestellt werden, bevor oder nachdem der Audiotherm auf den Visiotherm aufgesetzt wird bzw. bevor oder nachdem das jeweilige Kochprogramm ausgewählt wird. Alle Zeiten, die beim ersten Drücken der Tasten erscheinen, sind voreingestellte Werte, um die Eingabe zu erleichtern.

Kochzeit

Zur Überwachung der Kochzeit kann diese in den Audiotherm eingegeben werden. Die eingestellte Kochzeit beginnt abzulaufen, sobald die jeweilige Kochtemperatur erreicht ist.

➔ Einschalten.

➔ **+**-Taste drücken, um eine kurze Zeit (0:10) zu wählen oder die gewünschte Kochzeit zu erhöhen (gedrückt halten für Schnelllauf),

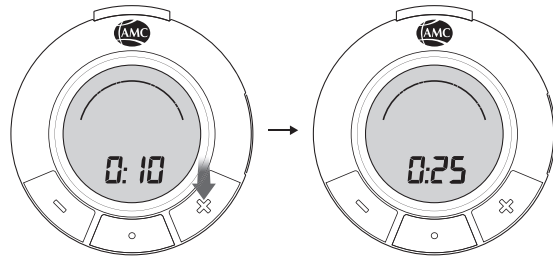

oder

➔ **-**-Taste drücken, um eine lange Zeit (1:00) zu wählen oder die gewünschte Kochzeit zu reduzieren (gedrückt halten für Schnelllauf).

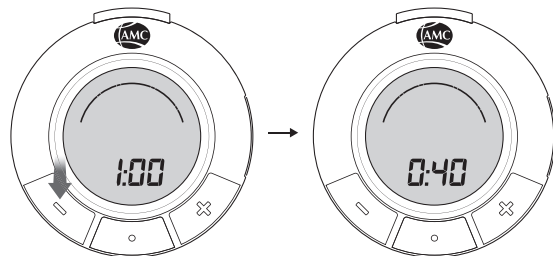

Zeiteinstellung „P“

➔ Nach dem Einschalten **-**-Taste und dann **+**-Taste drücken.



Ohne Zeiteingabe kontrolliert der Audiotherm die Temperatur für den gewünschten Kochvorgang ohne zeitliche Begrenzung. Die Kochzeit kann auch nach Starten des Kochvorgangs eingestellt und während ihrer gesamten Laufzeit geändert werden.

Beachten Sie die Beschreibungen und Tipps in „Kochen mit AMC“.

Geplantes Kochen „+“

Audiotherm kann im kontrollierten Betrieb mit dem Navigenio auf Stufe „A“ so eingestellt werden, dass der Kochvorgang zu einem späteren Zeitpunkt startet (Startaufschub).

- ➔ Einschalten und Kochzeit eingeben.
- Sobald im Display „+“ erscheint.

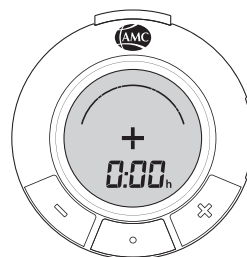

- ➔ +-Taste drücken, um eine kurze Startaufschubzeit (1:00) zu wählen oder die gewünschte Zeit zu erhöhen (gedrückt halten für Schnelllauf),

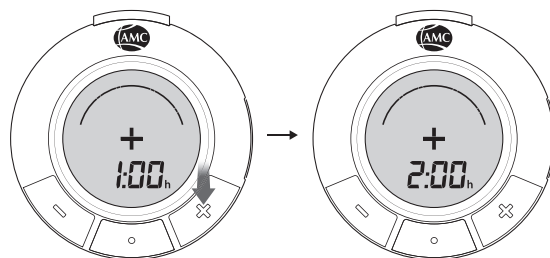

oder

- ➔ -Taste drücken, um eine lange Startaufschubzeit (8:00) zu wählen oder die gewünschte Zeit zu reduzieren (gedrückt halten für Schnelllauf).

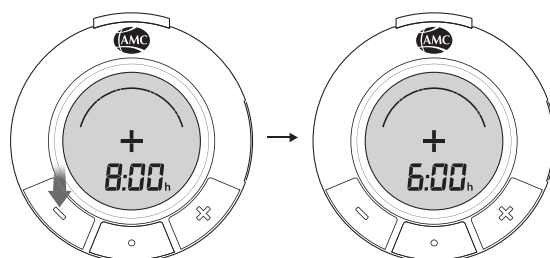

- Im Display werden abwechselnd die Kochzeit und die Startaufschubzeit mit „+“ angezeigt.



Die eingestellte Startaufschubzeit kann während ihrer gesamten Laufzeit geändert werden. Die Änderung der Startaufschubzeit bzw. der Kochzeit kann immer dann vorgenommen werden, wenn diese im Display angezeigt ist.

Beachten Sie die Beschreibungen und Tipps in „Kochen mit AMC“.

2.4.4 Zeitkontrolliertes Gratинieren und Backen

Zur Überwachung der Zeit kann diese in Audiotherm eingegeben werden. Die Zeit kann eingegeben werden, solange der auf die gewünschte Stufe eingeschaltete Navigenio abwechselnd blau/rot blinkt.

- ➔ Mittlere Taste drücken, bis das Back-Symbol erscheint.
- ➔ +-Taste drücken, um die gewünschte Zeit zu erhöhen (gedrückt halten für Schnelllauf).
- ➔ -Taste drücken, um die gewünschte Zeit zu reduzieren (gedrückt halten für Schnelllauf).

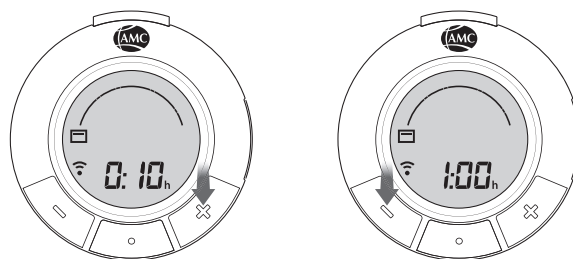

2.4.4 Küchenwecker einstellen

- ➔ Einschalten und mittlere Taste drücken.

Beispiel: Audiotherm nicht aufgesetzt.

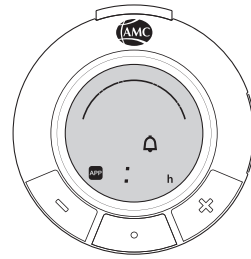

- ➔ **+**-Taste drücken, um die gewünschte Zeit zu erhöhen (gedrückt halten für Schnelllauf),

oder

- ➔ **-**-Taste drücken, um die gewünschte Zeit zu reduzieren (gedrückt halten für Schnelllauf).

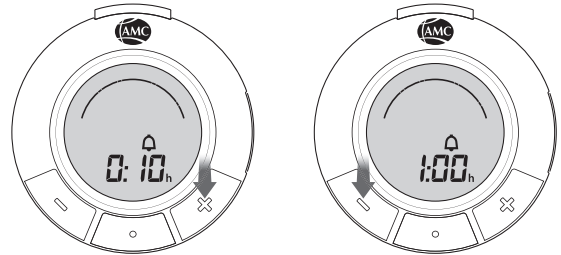

Beachten Sie die Beschreibungen und Tipps in „Kochen mit AMC“.

2.4.5 Kochprogramme wählen

- ➔ Durch Drücken der mittleren Taste können Kochprogramme ausgewählt werden.

Beispiel: Audiotherm auf Visiotherm aufgesetzt.

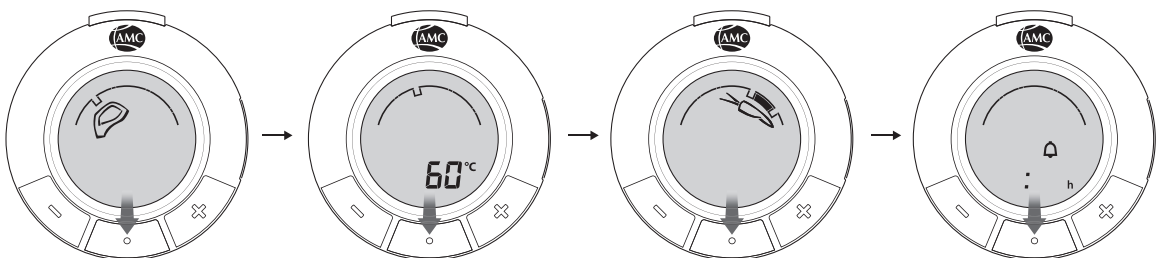

Programme können ausgewählt werden, bevor oder nachdem Audiotherm auf Visiotherm aufgesetzt wird.

2.4.6 Signalton abschalten

- ➔ Eine beliebige Taste drücken.
Andernfalls schaltet der Signalton nach 1 Minute ab.

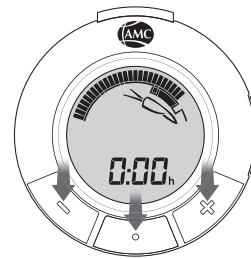

2.4.7 Audiotherm von Visiotherm abnehmen

- ➔ Entsperrtaste drücken und Audiotherm abnehmen.

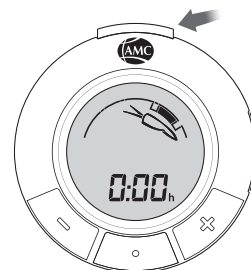

2.4.8 Audiotherm ausschalten

- ➔ Mittlere Taste für ca. 2 Sekunden gedrückt halten.

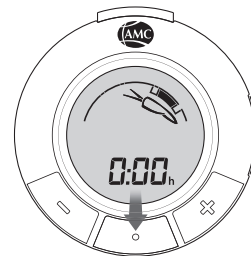

Audiotherm nach der Verwendung immer vom Visiotherm abnehmen und nie in Wasser tauchen oder in den Geschirrspüler geben.

2.5 Zusätzliche Funktionen

2.5.1 Ton ändern

- ➔ Einschalten.
- ➔ Gleichzeitig **+**-Taste und mittlere Taste drücken.

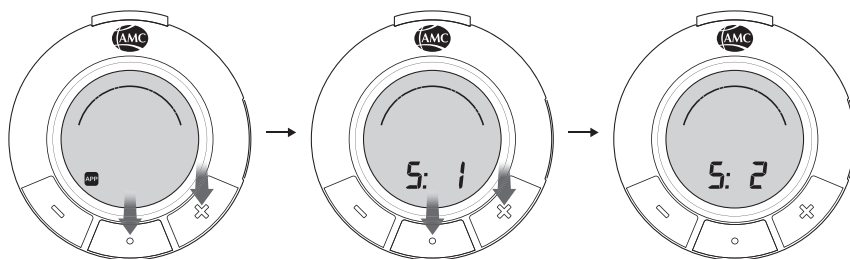

- Melodie (S: 1) oder Piepton (S: 2) kann ausgewählt werden.

2.5.2 Modus für Menschen mit Sehbehinderung

Audiotherm verfügt über einen Modus für Menschen mit Sehbehinderung (S: 0). Dieser kann mit der Audiotherm-App aktiviert werden. In diesem Modus wird beim Auswählen der Kochprogramme für jedes Kochprogramm eine andere Tonabfolge abgespielt. Zudem ist das Signal für „Stufe erhöhen“ (**+**) und „Stufe reduzieren“ (**-**) unterschiedlich. Alle anderen Signale entsprechen dem Modus „Piepton“ (S: 2).

2.5.3 Software und Hardware anzeigen

➔ Gleichzeitig -Taste und mittlere Taste drücken und halten.

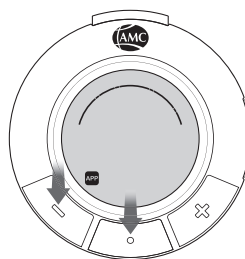

▪ Nach kurzer Anzeige aller Display-Symbole erscheint die Nummer der Software (z. B. 012) und danach die der Hardware (z. B. H01).

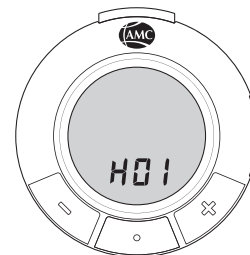
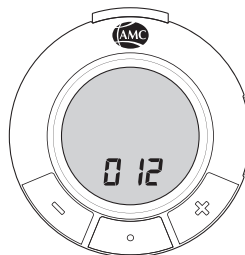

3. Was ist zu tun, wenn ...

... ein Kochprogramm gewählt wird, das auf dem verwendeten Visiotherm nicht zur Verfügung steht?

Beim Aufsetzen des Audiotherm ertönt ein Fehlerton und das zuvor gewählte Kochprogramm im Display erlischt.

➔ Prüfen, in welchem Programm gekocht werden soll.

... der auf ein Programm eingestellte Audiotherm den Kontakt zum Visiotherm verliert?

Es ertönt ein Fehlerton.

➔ Audiotherm wieder richtig in Visiotherm einrasten lassen.

... folgende Fehlermeldungen erscheinen?

E: 01

Fehler in der Audiotherm-Hardware.

➔ Kundenservice kontaktieren.

E: 02

➔ Überprüfen, ob alle Komponenten richtig aufgesetzt sind, und Kochvorgang neu starten.

E: 03

➔ Audiotherm ausschalten. Etwaige magnetische Störquellen aus der Umgebung entfernen.

➔ Audiotherm einschalten und Kochvorgang neu starten.

➔ Tritt der Fehler wiederholt auf, Kundenservice kontaktieren.

E: 04

Fehler in der Navigenio-Hardware.

➔ Kundenservice kontaktieren.

4. Pflege und Reinigung

- Audiotherm nur mit einem mit etwas Spülwasser angefeuchteten Tuch abwischen.
- Pflegen und reinigen Sie den Audiotherm regelmäßig, damit die Funktionsfähigkeit und Sicherheit gewährleistet sind.
- Sollte der Audiotherm einmal ins Wasser gefallen sein:
 - ➔ Den Audiotherm sofort ausschalten. Batteriefach öffnen, Batterien entfernen, sichtbares Wasser mit einem Tuch abtrocknen. Den geöffneten Audiotherm und das Batteriefach mindestens 2 Tage trocknen lassen.



5. Audiotherm und App

Der Audiotherm kann über eine App bedient werden.

6. Entsorgung



Verpackung, Audiotherm und Visiotherm gehören nicht in den Haushaltsmüll. Die Materialien sind wiederverwertbar. Umweltgerecht und entsprechend den örtlichen Vorschriften an geeigneten Sammelstellen entsorgen.



7. Technische Daten

- 1,5 V-Batterien der Größe AAA/LR03/Micro (z. B. Alkaline)
- Wiederaufladbare 1,2 V-Batterien der gleichen Baugröße (z. B. NiMH)



8. Konformitätserklärung

Der Audiotherm erfüllt die CE-Anforderungen gemäß der europäischen Funkgeräte-richtlinie 2014/53/EU. Eine vollständige Konformitätserklärung erhalten Sie unter der Adresse, die unten im Abschnitt „AMC Kundenservice“ angegeben ist.

9. AMC Kundenservice

Falls Sie Fragen oder Anregungen haben, nehmen Sie bitte Kontakt zum AMC Kundenservice auf.

Kundenservice

AMC Deutschland

Kundenservice
55408 Bingen

+49 (0) 6721-180 01

AMC (Schweiz)

Alfa Metalcraft AG
Buonaserstrasse 30
6343 Rotkreuz

+41 799 51 11

AMC Österreich

Handelsgesellschaft mbH
Handelskai 388 / Top 222
1020 Wien

+43 (0) 1 2582618-61

AMC Visiotherm & Audiotherm

User Manual

Table of Contents

1. Visiotherm	
1.1 Intended use and safety	17
1.1.1 Suitable lid	17
1.1.2 Safety	17
1.2 Composition and display	17
1.3 Assembly and first use	17
1.4 Care and Maintenance	18
2. Audiotherm	
2.1 Intended use and safety	18
2.2 Using the Audiotherm for the first time / changing the batteries	19
2.3 Composition and display	20
2.3.1 Composition	20
2.3.2 Display	20
2.4 Features	21
2.4.1 Placing onto the Visiotherm	21
2.4.2 Switching on	21
2.4.3 Setting the time	22
2.4.4 Time-controlled gratinating and baking	23
2.4.5 Setting the kitchen timer	24
2.4.6 Selecting cooking programs	24
2.4.7 Switching the acoustic signal off	25
2.4.8 Removing the Audiotherm from the Visiotherm	25
2.4.9 Switching the Audiotherm off	25
2.5 Additional features	25
2.5.1 Changing the sound	25
2.5.2 Mode for visually impaired people	25
2.5.3 Displaying the software and hardware	26
3. What to do when...	26
4. Care and Maintenance	27
5. Audiotherm and App	27
6. Disposal	27
7. Technical Data	27
8. Declaration of Conformity	27
9. AMC Customer Service	27

The Visiotherm and Audiotherm are exclusively intended for proper use within the household. Hazards may arise from improper use.

Before using the Visiotherm and Audiotherm, please read the User Manual carefully – especially the information on proper use and safety. Retain the User Manual and pass it on to subsequent owners.

Please also carefully read the “Cooking With AMC” brochure and the corresponding user manuals of the other AMC products that are used with it.

Symbol Meanings



Instructions important for safety. Non-observance can lead to injury or damage.



Poor operating condition or improper use.



Good operating condition or proper use.



Useful user information.



Environmental protection, ecology, and economy information.



Process steps are highlighted with an arrow.

Visiotherm and Audiotherm User Manual version: 07/2020

1. Visiotherm

When placed on AMC lids, the Visiotherm measures the temperature of the respective pot or pan and shows it on the display. Visiotherm thus visually indicates whether the desired temperature in the pot or pan has been reached.

1.1 Intended use and safety

1.1.1 Suitable lid

The Visiotherm is suitable for all AMC pot and pan lids.



1.1.2 Safety

- Note heat-related hazards; when the lid is hot, touch only the Visiotherm.
- The Visiotherm is equipped with a magnet to transmit the temperature. A pacemaker can be switched to test mode and cause discomfort if it is less than 2 cm from the Visiotherm viewing window.
- Credit cards, EC cards, data carriers, hearing aids or mechanical watches can be affected if they are less than 2 cm from the viewing window of the Visiotherm.
- Do not use the Visiotherm in the oven or microwave.

1.2 Composition and display

- 1 Indicator
- 2 Roasting window
- 3 Turning point
- 4 Vegetable window
- 5 "Vegetable" temperature range
- 6 Stop window

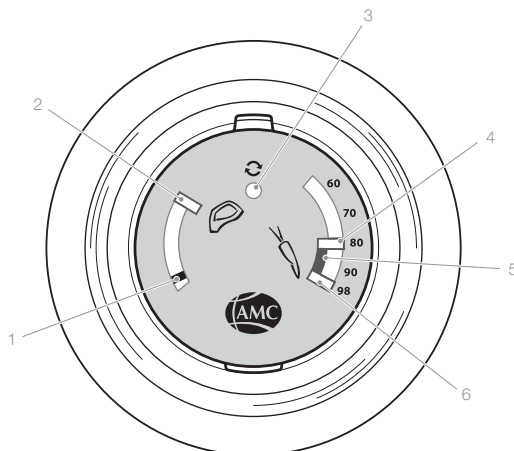

Follow the descriptions and tips in the "Cooking with AMC" brochure.

1.3 Assembly and first use

- ➔ Before using the Visiotherm for the first time, wipe it down with a damp cloth.
- ➔ Screw the Visiotherm onto the lid.

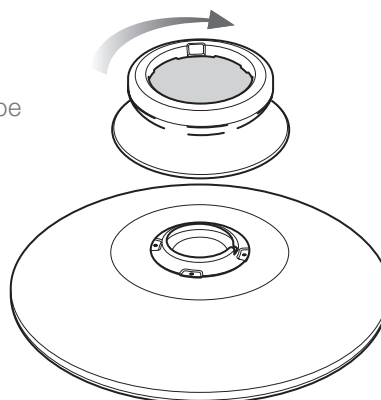

1.4 Care and Maintenance

- ➔ Unscrew the Visiotherm from the lid; clean both in the dishwasher or by hand.
- ➔ Use standard household machine-friendly cleaners for the dishwasher.
- ➔ When cleaning by hand, use a dishcloth or soft sponge and neutral detergent.



2. Audiotherm

2.1 Intended use and safety

Together with the Visiotherm, the Audiotherm monitors the cooking process. The Audiotherm displays the temperature in the pot as measured by the Visiotherm. It serves as an acoustic temperature and cooking time monitor and facilitates controlled cooking with the Navigenio.

Suitable lid

- Lid with Visiotherm
- EasyQuick steam cooking lid with Visiotherm E
- Quick cooking lid “Secuquick softline” with Visiotherm S



Avoid damage and improper use.

- Do not use the Audiotherm in the oven or microwave. Do not expose it to temperatures above 70 °C.
- Never immerse the Audiotherm in water or put it in the dishwasher.
- The Audiotherm is used to monitor or control the cooking process. Use the Audiotherm for this purpose only. Hazards may arise from improper use.
- The Audiotherm contains batteries. Batteries must not get into the hands of children, as they can be swallowed.
- Use only recommended, equivalent-type batteries (as according to Section 5).
- Do not attempt to recharge non-rechargeable batteries.

Please also refer to the EasyQuick, Secuquick softline, and Navigenio user manuals as well as the notes and tips in the “Cooking With AMC” brochure.



Supervision

- The cooking process must be supervised. To monitor the cooking process acoustically, use the Audiotherm only when within earshot of it.
- Unattended, uncontrolled cooking can lead to overheating. Food can spoil, and the pot can be damaged or destroyed. Risk of accidents and fire.
- The device can be used by children who are at least 8 years of age, persons with limited physical, sensory, or mental abilities, as well as persons lacking in experience or knowledge. They nevertheless must be supervised or instructed in how to use the device safely and must understand the risks involved. This also applies to acoustic monitoring by the visually impaired (see Section 2.5.2).

2.2 Using the Audiotherm for the first time / changing the batteries

First use:

The Audiotherm comes with two batteries (type as per Section 5).
Insert the batteries before first use.

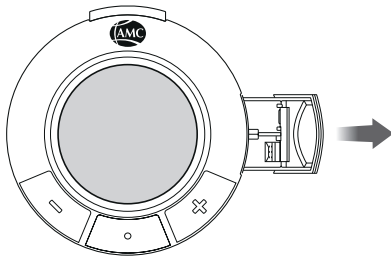

➔ Open the battery compartment and pull out the battery holder.

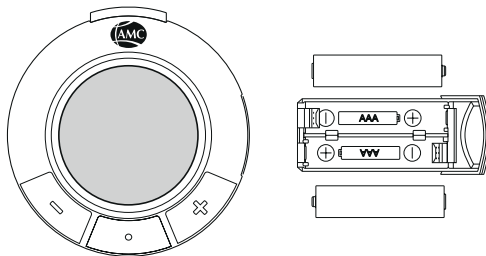

➔ Insert the batteries correctly as shown.

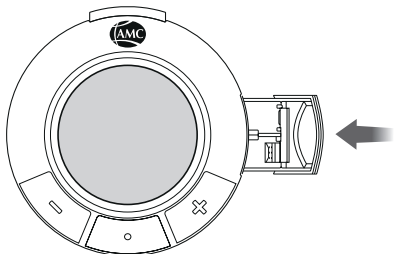

➔ Insert the battery holder into the Audiotherm. When it clicks, it's closed.

Changing the batteries:

If the battery indicator is visible in the display, it's time to replace the batteries.



Dispose of used batteries as according to local regulations!

2.3 Composition and display

2.3.1 Composition

- 1 Unlock button
- 2 **-**-button
- 3 Middle button
- 4 **+**-button

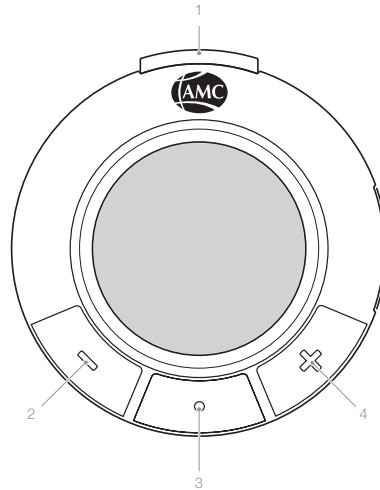

2.3.2. Display

- 1 Soft symbol
- 2 Roasting symbol
- 3 Vegetable symbol
- 4 Orientation line
- 5 Turning point symbol
- 6 Turning point
- 7 Steam symbol
- 8 60 °C symbol
- 9 Minus display

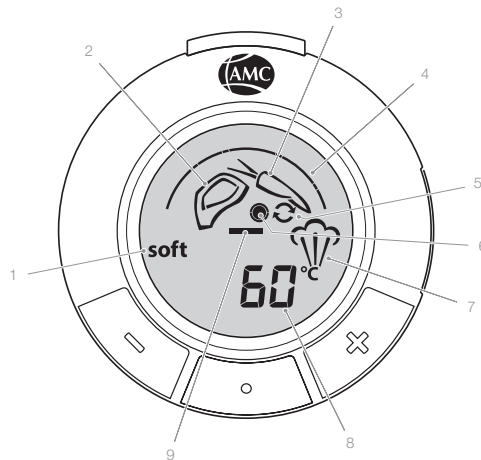

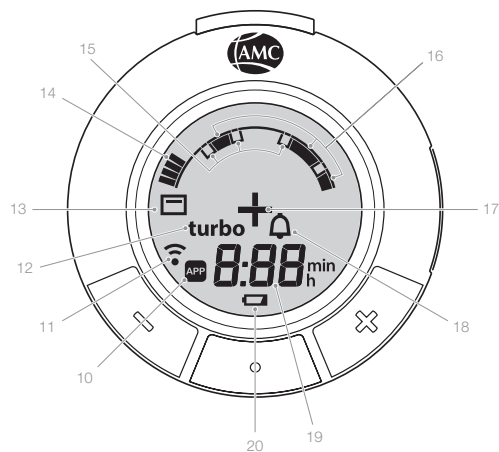

- 10 "App" connection
- 11 "Navigenio" connection
- 12 Turbo symbol
- 13 Bake symbol
- 14 Temperature scale
- 15 Action points
- 16 Temperature ranges
- 17 Plus display
- 18 Kitchen timer symbol
- 19 Time display
- 20 Battery display



2.4 Features

The AMC Cooking System includes various cooking methods, for which the Audiotherm can be used in two different ways.

Manual cooking with the Visiotherm and Audiotherm:

- The Audiotherm displays the current temperature and emits acoustic signals  to indicate when something needs to be done. The Audiotherm display shows what needs to be done.
- Via an acoustic signal , the Audiotherm indicates that the cooking time has elapsed.
- The user is responsible for operating the cooktop.

Self-controlled cooking:

When cooking on the “Navigenio” mobile hotplate, the Audiotherm facilitates self-controlled cooking.

- Via a radio link to the Navigenio, the Audiotherm independently controls the entire cooking process.
- After switching on the Navigenio to “A”, the Navigenio’s operation is taken over by the Audiotherm.
- The Audiotherm emits an acoustic signal  to indicate that the set cooking time has elapsed.



All cooking features (with the exception of planned cooking and the 60 °C program) can be carried out manually or in a self-controlled manner.

Be sure to follow the descriptions and tips in the “Cooking with AMC” brochure.

2.4.1 Placing onto the Visiotherm

- ➔ With the push-button facing upward, place the Audiotherm onto the Visiotherm and let it click into place.

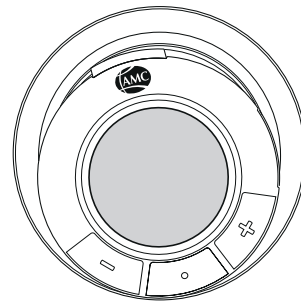

2.4.2 Switching on

- ➔ Press any button.

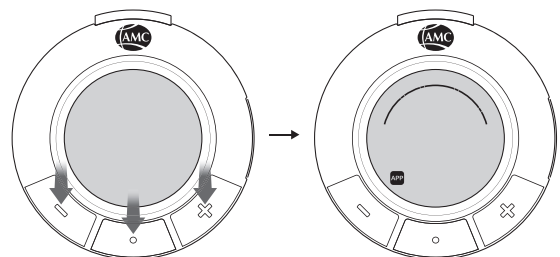

2.4.3 Setting the time



Times can be set before or after the Audiotherm is placed onto the Visiotherm (or before or after the respective cooking program is selected). To facilitate entry, all times that appear when the buttons are pressed for the first time are preset values.

Cooking time

To monitor the cooking time, it can be entered into the Audiotherm. The set cooking time begins as soon as the respective cooking temperature has been reached.

➔ Switch on.

➔ Press the **+**-button to select a short time (0:10) or to increase the desired cooking time (press and hold for fast mode),

or

➔ Press the **-**-button to select a long time (1:00) or to reduce the desired cooking time (press and hold for fast mode).

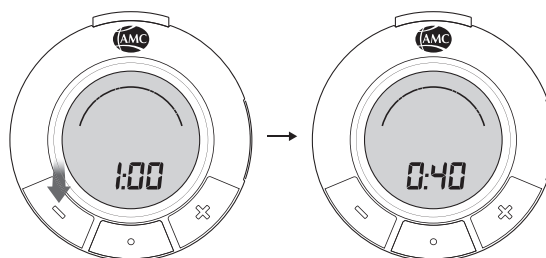
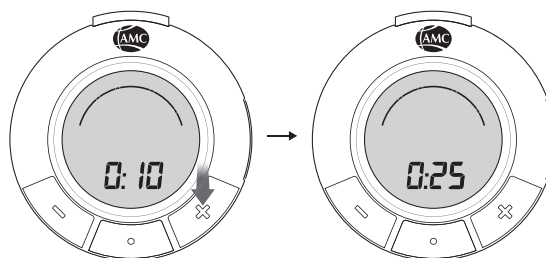

Time setting "P"

➔ After switching on, press the **-**-button and then the **+**-button.

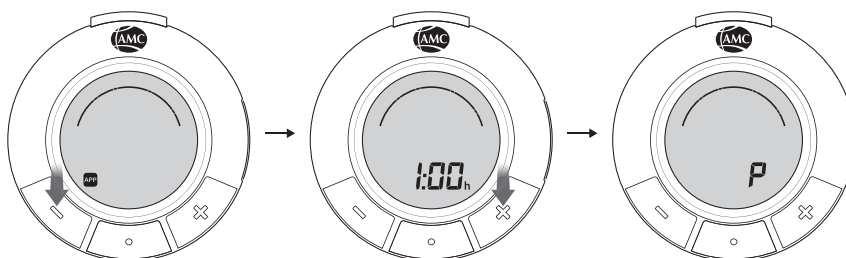

If no time is input, the Audiotherm controls the temperature for the desired cooking process with no time limit. The cooking time can also be set after the cooking process has begun and can be changed whenever desired.

Be sure to follow the descriptions and tips in "Cooking with AMC" Brochure.

“+” planned cooking

In controlled operation, the Audiotherm can be set to level “A” with the Navigenio so that the cooking process starts at a later time (start delay).

➔ Switch on and enter the cooking time.

- As soon as “+” appears in the display.

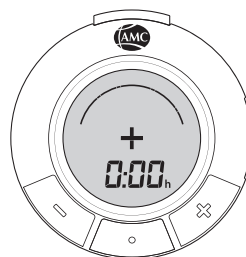

➔ Press the +-button to select a short start-delay time (1:00) or to increase the desired time (press and hold for fast mode),

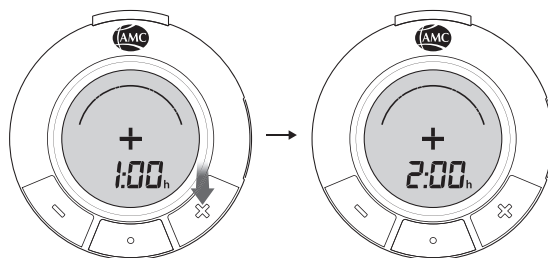

or

➔ Press the -button to select a long start-delay time (8:00) or to reduce the desired time (press and hold for fast mode).

- With “+”, the display alternates between the cooking time and the start-delay time.

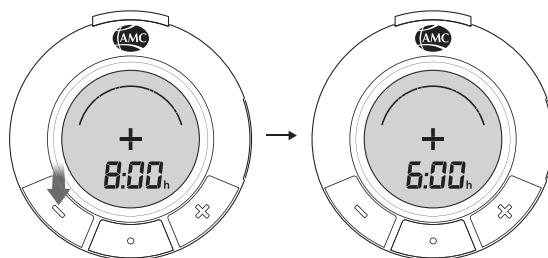

The set start-delay time can be changed whenever desired.

The start-delay time or cooking time can always be changed whenever it is shown in the display.

Be sure to follow the descriptions and tips in the “Cooking with AMC” brochure.

2.4.4 Time-controlled gratinating and baking

To monitor the time, the time can be entered into the Audiotherm. The time can be entered when the Navigenio (which must be switched on to the desired level) flashes blue/red.

➔ Press the middle button until the Baking symbol appears.

➔ Press the +-button to increase the desired time (press and hold for fast mode).

➔ Press the -button to reduce the desired time (press and hold for fast mode).

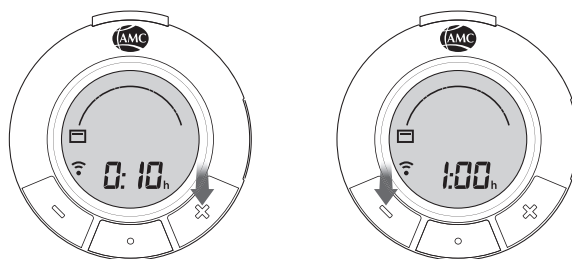

2.4.5 Setting the kitchen timer

- ➔ Switch on and press middle button.

Example: The Audiotherm has not been placed on.

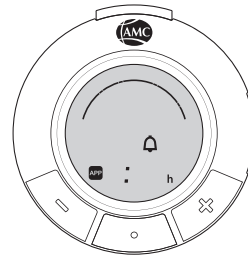

- ➔ Press the **+**-button to increase the desired time (press and hold for fast mode),

or

- ➔ Press the **-**-button to reduce the desired time (press and hold for fast mode)

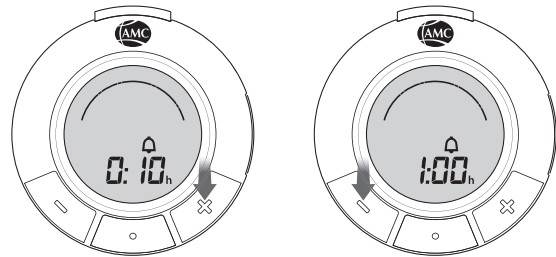

Be sure to follow the descriptions and tips in the “Cooking with AMC” Brochure.

2.4.6 Selecting cooking programs

- ➔ By pressing the middle button, cooking programs can be selected.

Example: The Audiotherm is placed onto the Visiotherm.

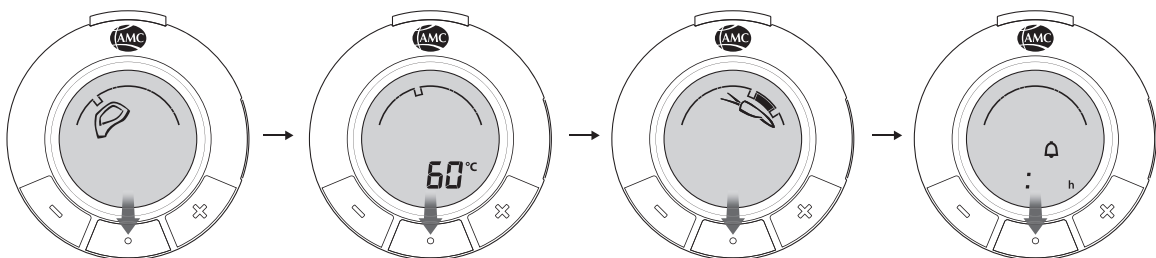

Programs can be selected before or after the Audiotherm is placed onto the Visiotherm.

2.4.7 Switching the acoustic signal off

- ➔ Press any button.
Otherwise the acoustic signal switches off after 1 minute.

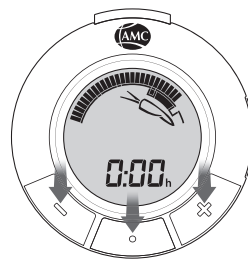

2.4.8 Removing the Audiotherm from the Visiotherm

- ➔ Press the unlock button and remove Audiotherm.

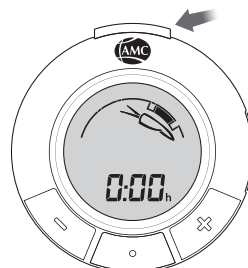

2.4.9 Switching the Audiotherm off

- ➔ Keep middle button pressed for about 2 seconds.

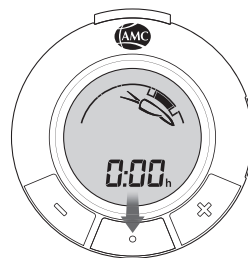

After use, always remove the Audiotherm from the Visiotherm. Never immerse the Audiotherm in water or put it in the dishwasher.

2.5 Additional features

2.5.1 Changing the sound

- ➔ Switch on.
- ➔ Simultaneously press the **+**-button and middle button.

- A Melody (S: 1) or Beep (S: 2) can be selected.

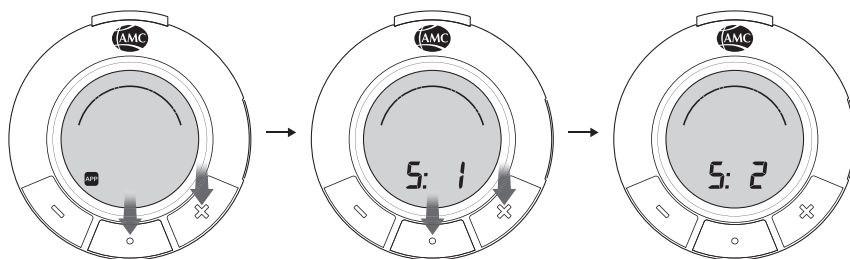

2.5.2 Mode for visually impaired people

The Audiotherm has a mode for the visually impaired (S: 0). It can be activated with the Audiotherm app. In this mode, when selecting the cooking programs a different sequence of sounds is played for each one. In addition, the respective sounds for “increase level” (**+**) and “decrease level” (**-**) are different. All other sounds match the “Beep” mode (S: 2).

2.5.3 Displaying the software and hardware

- ➔ Simultaneously press and hold the -button and middle button.

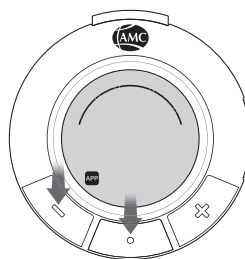

- After a short indication of all the display symbols, the software number (e.g. 012) and then the hardware number (e.g. H01) appears.

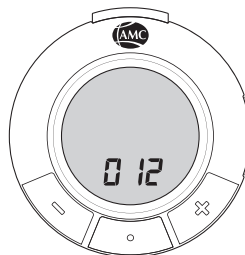

3. What to do when...

...a cooking program is selected that is not available on the Visiotherm being used?

When the Audiotherm is put on, an error tone sounds and the selected cooking program disappears from the display.

- ➔ Check to see which program should be used to cook.

...the Audiotherm that has been set to a program loses contact with the Visiotherm?

An error tone sounds.

- ➔ Join the Audiotherm and Visiotherm together correctly.

...the following error messages appear?

E: 01

Audiotherm hardware error.

- ➔ Contact customer service.

E: 02

- ➔ Check that all components are correctly positioned and restart the cooking process.

E: 03

- ➔ Switch the Audiotherm off. Remove any sources of magnetic interference from the surrounding area.
- ➔ Switch the Audiotherm on and restart the cooking process.
- ➔ If the error occurs repeatedly, contact customer service.

E: 04

Navigenio hardware error.

- ➔ Contact customer service.

4. Care and maintenance

- Use only a cloth that's been moistened with a little rinsing water to wipe down the Audiotherm.
- Maintain and clean the Audiotherm regularly to ensure its functionality and safety.
- Should the Audiotherm ever fall into water:
 - ➔ Switch off the Audiotherm immediately. Open the battery compartment, remove the batteries, and dry any visible water with a cloth. Leave the opened Audiotherm and battery compartment to dry for at least two days.



5. Audiotherm and App

The Audiotherm can be operated via an app.

6. Disposal



The packaging, Audiotherm, and Visiotherm do not belong in household waste. The materials are recyclable. Carry out disposal in an environmentally friendly manner and according to local regulations at suitable collection points.



7. Technical Data

- 1.5 V batteries size AAA/LR03/Micro (e.g. alkaline)
- Rechargeable 1.2 V batteries of the same size (e.g. NiMH)



8. Declaration of Conformity

The Audiotherm meets the CE requirements according to the European Radio Equipment Directive 2014/53/EU. A complete Declaration of Conformity can be obtained from the address listed in the "AMC Customer Service" section below.

9. AMC Customer Service

If you have any questions or suggestions, please contact AMC Customer Service.

Customer service

AMC International
Alfa Metalcraft Corporation AG
Buonaserstrasse 30
6343 Rotkreuz, Switzerland
+41 41 - 799 52 22
info@amc.info

Visiotherm e Audiotherm AMC

Istruzioni per l'uso

Indice

1. Visiotherm	
1.1 Utilizzo conforme all'uso e sicurezza	30
1.1.1 Coperchi adatti	30
1.1.2 Sicurezza	30
1.2 Struttura e display	30
1.3 Montaggio e messa in funzione	31
1.4 Cura e manutenzione	31
2. Audiotherm	
2.1 Utilizzo conforme all'uso e sicurezza	31
2.2 Messa in funzione di Audiotherm e sostituzione delle batterie	32
2.3 Struttura e display	33
2.3.1 Struttura	33
2.3.2 Display	33
2.4 Funzioni	34
2.4.1 Posizionamento su Visiotherm	34
2.4.2 Accensione	34
2.4.3 Impostazione del tempo	35
2.4.4 Gratinatura e cottura con controllo del tempo	36
2.4.5 Impostazione del timer	37
2.4.6 Selezione del programma di cottura	37
2.4.7 Disattivazione del segnale acustico	38
2.4.8 Rimozione di Audiotherm da Visiotherm	38
2.4.9 Spegnimento di Audiotherm	38
2.5 Funzioni aggiuntive	38
2.5.1 Modifica del suono	38
2.5.2 Modulo per persone con disabilità visive	39
2.5.3 Visualizzazione del software e dell'hardware	39
3. Che cosa fare se ...	39
4. Cura e manutenzione	40
5. Audiotherm e app	40
6. Smaltimento	40
7. Dati tecnici	40
8. Dichiarazione di conformità	40
9. Assistenza Clienti AMC	40

Visiotherm e Audiotherm sono destinati esclusivamente all'uso domestico e conforme allo scopo previsto. Un uso improprio può causare danni.

Prima di usare Visiotherm e Audiotherm leggere attentamente le istruzioni, in particolare le indicazioni sull'uso conforme e la sicurezza. Conservare le istruzioni e consegnarle al proprietario successivo.

Leggere attentamente anche la brochure "Cucinare con AMC" e le rispettive istruzioni per l'uso dei prodotti AMC usati congiuntamente.

Significato dei simboli



Istruzioni importanti per la sicurezza. L'inosservanza può causare lesioni o danni.



Scarse condizioni di funzionamento o uso improprio.



Buone condizioni di funzionamento o uso corretto.



Indicazioni utili per gli utenti.



Indicazioni per la salvaguardia dell'ambiente, l'ecologia e l'economia.



Le fasi di lavoro sono indicate con una freccia.

Versione delle istruzioni per l'uso di Visiotherm e Audiotherm: 07/2020

1. Visiotherm

Visiotherm posizionato sui coperchi AMC misura la temperatura all'interno della pentola e della padella e la mostra sul display. Visiotherm mostra in maniera visiva se nella pentola o nella padella è stata raggiunta la temperatura desiderata.

1.1 Utilizzo conforme all'uso previsto e sicurezza

1.1.1 Coperchi adatti

Visiotherm è adatto a tutti i coperchi delle pentole e delle padelle AMC.



1.1.2 Sicurezza

- Tenere conto dei pericoli derivanti dal calore, toccare i coperchi caldi solo tramite Visiotherm.
- Visiotherm è dotato di un magnete per la trasmissione della temperatura. Per i portatori di pacemaker, restare a una distanza superiore ai di 2 cm dalla finestra di visualizzazione di Visiotherm.
- Le carte di credito, le carte EC, i supporti dati, gli apparecchi acustici o gli orologi meccanici possono danneggiarsi se si trovano a meno di 2 cm dalla finestra di visualizzazione di Visiotherm.
- Non usare Visiotherm in forno o nel microonde.

1.2 Struttura e display

- | | |
|---|-----------------------------|
| 1 | Indicatore |
| 2 | Finestra "Carne" |
| 3 | Punto di girata |
| 4 | Finestra "Verdura" |
| 5 | Campo temperatura "Verdura" |
| 6 | Finestra "Stop" |

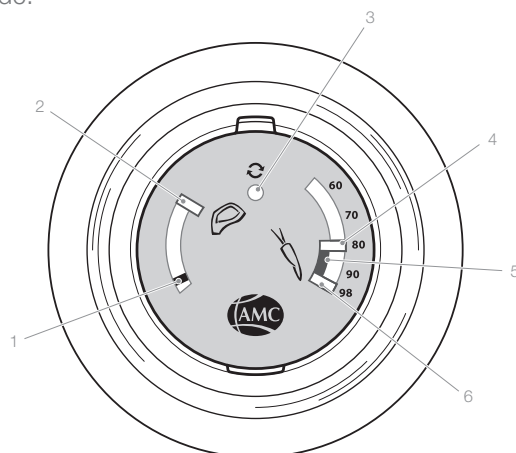

Osservare le descrizioni e i consigli contenuti nella brochure "Cucinare con AMC".

1.3 Montaggio e messa in funzione

- ➔ Prima del prima messa in funzione pulire Visiotherm con un panno umido.
- ➔ Avvitare Visiotherm sul coperchio.

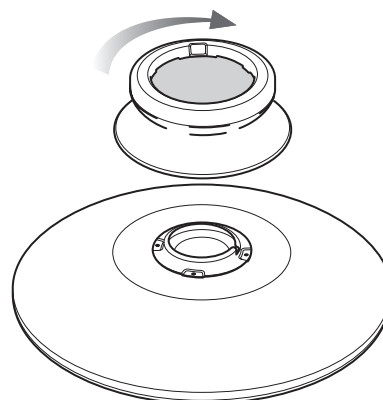

1.4 Cura e manutenzione

- ➔ Svitare Visiotherm dal coperchio e lavarli entrambi in lavastoviglie o a mano.
- ➔ Se lavati in lavastoviglie, utilizzare un detersivo per lavastoviglie di uso domestico.
- ➔ In caso di pulizia a mano utilizzare uno strofinaccio o una spugna morbida e un detersivo neutro.



2. Audiotherm

2.1 Utilizzo conforme all'uso previsto e sicurezza

Audiotherm, in combinazione con Visiotherm, monitora il processo di cottura. Audiotherm mostra la temperatura misurata da Visiotherm all'interno della pentola, funge da monitoraggio acustico della temperatura e del tempo di cottura e si occupa della gestione della cottura controllata con Navigenio.

Coperchi adatti

- Coperchio con Visiotherm
- Coperchio per la cottura a vapore EasyQuick con Visiotherm E
- Coperchio per la cottura veloce "Secuquick" con Visiotherm S



Evitare danneggiamenti e l'uso improprio.

- Non usare Audiotherm in forno o nel microonde e non esporlo a temperature superiori a 70°C.
- Non immergere mai Audiotherm in acqua e non lavarlo mai in lavastoviglie.
- Audiotherm viene utilizzato per il monitoraggio o la gestione del processo di cottura. Utilizzare Audiotherm esclusivamente per questo scopo. L'uso improprio può essere pericoloso.
- Audiotherm contiene delle batterie. Tenere le batterie fuori dalla portata dei bambini, poiché potrebbero essere ingerite.
- Utilizzare soltanto le batterie raccomandate e dello stesso tipo (come riportato nel capitolo 5).
- Non tentare di ricaricare le batterie non ricaricabili.

Rispettare le istruzioni per l'uso di EasyQuick, Secuquick e Navigenio, nonché le indicazioni e i consigli contenuti nella brochure "Cucinare con AMC".



Sorveglianza

- Sorvegliare il processo di cottura. Utilizzare Audiotherm per il monitoraggio acustico del processo di cottura esclusivamente a portata d'orecchio.
- Una cottura non sorvegliata né controllata può provocare un surriscaldamento. Le pietanze possono rovinarsi e la pentola può danneggiarsi o rompersi irrimediabilmente. Pericolo di incidenti e incendi.
- L'apparecchio può essere usato da bambini con un'età superiore agli otto anni o da persone con ridotte capacità fisiche, sensoriali o mentali, oppure inesperte o incompetenti, a condizione che siano sorvegliati o siano stati istruiti riguardo all'uso sicuro dell'apparecchio e abbiano compreso i pericoli derivanti dall'utilizzo. Ciò riguarda anche il monitoraggio acustico da parte di persone con disabilità visive (vedere capitolo 2.5.2).

2.2 Messa in funzione di Audiotherm e sostituzione delle batterie

Messa in funzione:

La dotazione di Audiotherm include due batterie (tipo riportato nel capitolo 5). Inserire le batterie per mettere in funzione l'apparecchio.

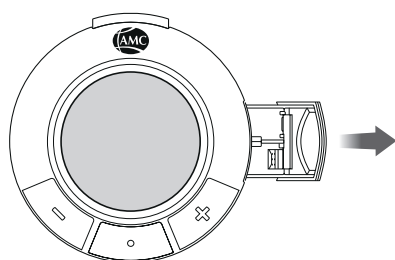

➔ Aprire il vano batterie e rimuovere il supporto delle batterie.

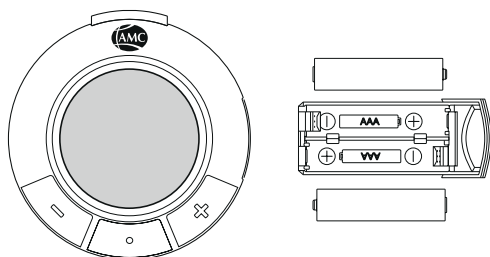

➔ Inserire correttamente le batterie come raffigurato.

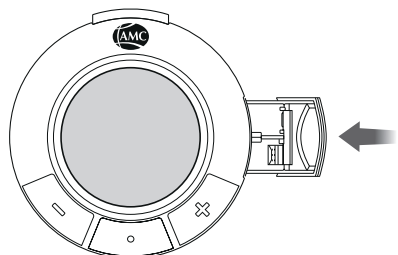

➔ Collocare il supporto delle batterie in Audiotherm e chiuderlo con un "clic".

Sostituzione delle batterie:

Se l'indicatore dello stato delle batterie è visibile sul display, sostituire le batterie il prima possibile.



Smaltire le batterie esauste nel rispetto delle normative locali!

2.3 Struttura e display

2.3.1 Struttura

- 1 Tasto di sblocco
- 2 Tasto **-**
- 3 Tasto intermedio
- 4 Tasto **+**

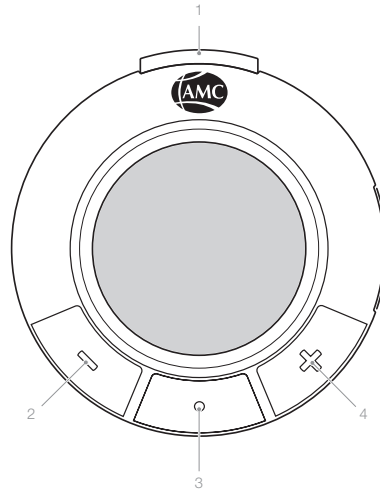

2.3.2. Display

- 1 Simbolo "Soft"
- 2 Simbolo "Carne"
- 3 Simbolo "Verdura"
- 4 Linea di base
- 5 Simbolo "Punto di girata"
- 6 Punto di girata
- 7 Simbolo "Vapore"
- 8 Simbolo "60°C"
- 9 Simbolo **-**

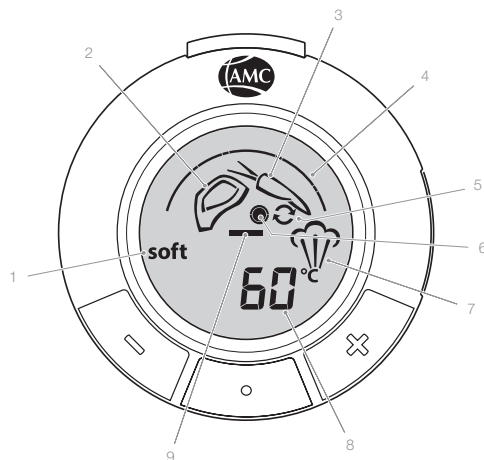

- 10 Connessione "App"
- 11 Connessione "Navigenio"
- 12 Simbolo "Turbo"
- 13 Simbolo "Cuocere al forno"
- 14 Scala della temperatura
- 15 Punti di azione
- 16 Intervalli di temperatura
- 17 Simbolo **+**
- 18 Simbolo del timer da cucina
- 19 Indicazione del tempo
- 20 Indicazione dello stato delle batterie

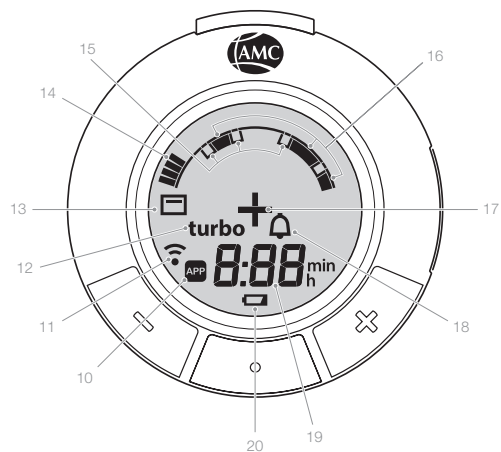

2.4 Funzioni

Il Sistema di cottura AMC include numerosi metodi di cottura. Audiotherm può essere utilizzato in due modi diversi.

Cottura manuale con Visiotherm e Audiotherm:

- Audiotherm mostra la temperatura attuale e avverte tramite dei segnali acustici  se ci sono azioni da eseguire. Mostra sul display che cosa c'è da fare.
- Audiotherm avverte tramite un segnale acustico  che il tempo di cottura è terminato.
- La gestione della zona di cottura è effettuata dall'utente.

Cottura controllata:

L'utilizzo del piano di cottura mobile "Navigenio" consente ad Audiotherm di cuocere in maniera controllata.

- Audiotherm monitora autonomamente tutto il processo di cottura attraverso un collegamento wireless con Navigenio.
- Dopo avere azionato Navigenio in modalità "A", il funzionamento di Navigenio viene gestito da Audiotherm.
- Audiotherm avverte tramite un segnale acustico  che il tempo di cottura impostato è terminato.



Tutte le funzioni di cottura (eccezione: la cottura programmata e il programma 60°C) possono avvenire sia in modalità manuale che in modalità controllata.

Osservare le descrizioni e i consigli contenuti nei "Metodi di cottura AMC".

2.4.1 Posizionamento su Visiotherm

- ➔ Posizionare Audiotherm su Visiotherm con il pulsante rivolto verso l'alto e innestarlo con un "clic".

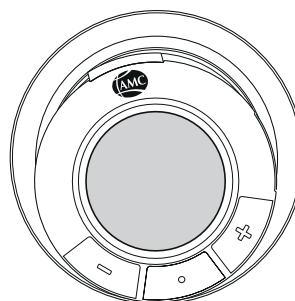

2.4.2 Accensione

- ➔ Premere un tasto qualsiasi.

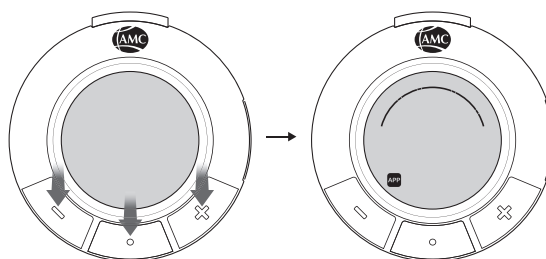

2.4.3 Impostazione del tempo



I tempi possono essere impostati prima o dopo aver posizionato Audiotherm su Visiotherm oppure prima o dopo aver selezionato il programma di cottura. Tutti i tempi che appaiono premendo per la prima volta un tasto sono valori preimpostati per facilitare l'inserimento.

Tempo di cottura

Al fine di monitorare il tempo di cottura, questo può essere impostato su Audiotherm. Il tempo di cottura impostato inizia a trascorrere non appena la temperatura di cottura viene raggiunta.

➔ Accendere.

➔ Premere il tasto **+** per selezionare un tempo breve (0:10) o per aumentare il tempo di cottura selezionato (tenere premuto per avanzare rapidamente),

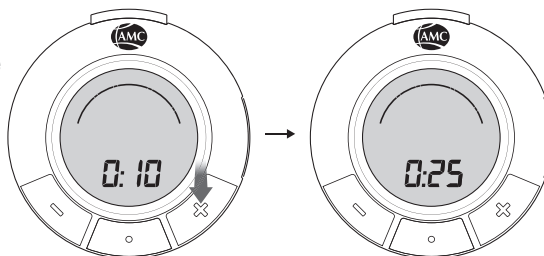

oppure

➔ Premere il tasto **-** per selezionare un tempo lungo (1:00) o per ridurre il tempo di cottura (tenere premuto per avanzare rapidamente).

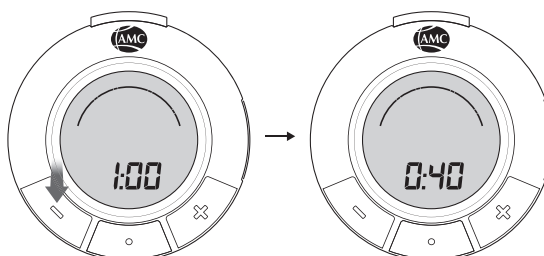

Impostazione del tempo "P"

➔ Dopo l'accensione, premere il tasto **-** e poi il tasto **+**.

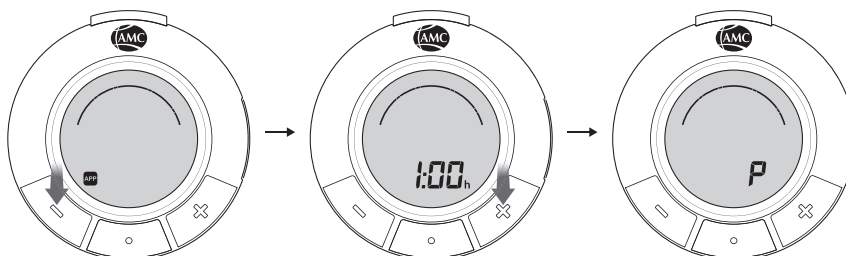

Se il tempo non viene impostato, Audiotherm monitora la temperatura per il metodo di cottura desiderato senza limitazione di tempo. Il tempo di cottura può essere impostato anche all'inizio della cottura e modificato durante la sua intera durata.

Osservare le descrizioni e i consigli contenuti nei "Metodi di cottura AMC".

Cottura pianificata “+”

Nella modalità controllata con Navigenio su “A”, Audiotherm può essere impostato in modo che la cottura si avvi in un secondo momento (avvio ritardato).

- ➔ Accendere e inserire il tempo di cottura.
- Non appena “+” appare sul display.

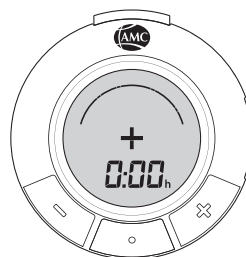

- ➔ Premere il tasto + per selezionare un tempo di avvio ritardato breve per l'avvio ritardato (1:00) o per aumentare il tempo desiderato (tenere premuto per avanzare rapidamente),

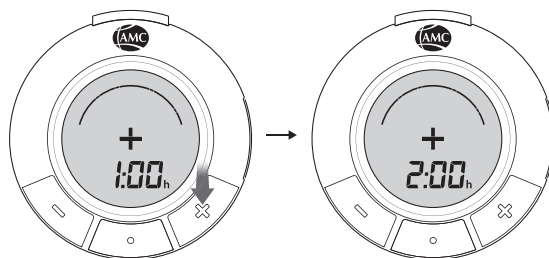

oppure

- ➔ Premere il tasto - per selezionare un tempo di avvio ritardato lungo (8:00) o per ridurre il tempo desiderato (tenere premuto per avanzare rapidamente).

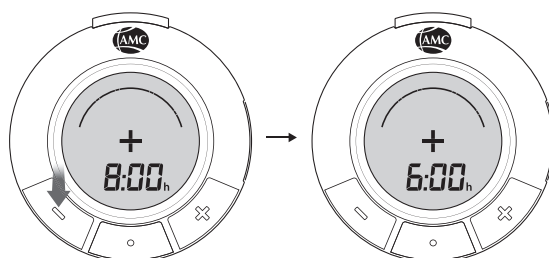

- Il display mostra alternativamente il tempo di cottura e l'avvio ritardato con “+”.



L'avvio ritardato impostato può essere modificato durante l'intera durata del processo. Il tempo di avvio ritardato il tempo di cottura possono essere sempre modificati, se visualizzati sul display.

Osservare le descrizioni e i consigli contenuti nei “Metodi di cottura AMC”.

2.4.4 Gratinatura e cottura con controllo del tempo

Al fine di monitorare il tempo, questo può essere impostato su Audiotherm. È possibile inserire il tempo mentre Navigenio regolato sul livello desiderato lampeggia alternativamente di blu/rosso.

- ➔ Premere il tasto intermedio finché non appare il simbolo “Cuocere al forno”.
- ➔ Premere il tasto + per aumentare il tempo desiderato (tenere premuto per avanzare rapidamente).
- ➔ Premere il tasto - per ridurre il tempo desiderato (tenere premuto per avanzare rapidamente).

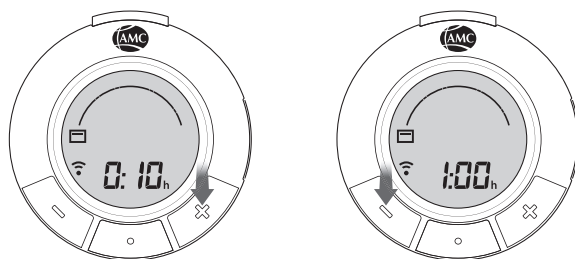

2.4.5 Impostazione del timer da cucina

- ➔ Accendere e premere il tasto intermedio.

Esempio: Audiotherm non posizionato.

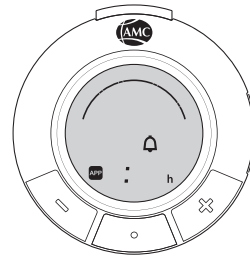

- ➔ Premere il tasto **+** per aumentare il tempo desiderato (tenere premuto per avanzare rapidamente),

oppure

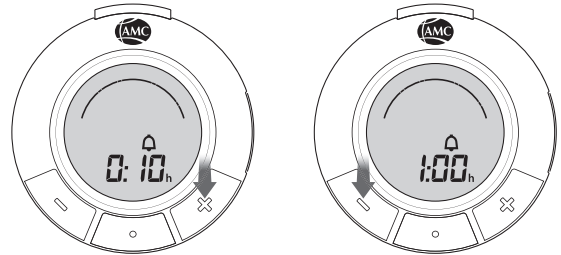

- ➔ Premere il tasto **-** per ridurre il tempo desiderato (tenere premuto per avanzare rapidamente)

Osservare le descrizioni e i consigli contenuti nei “Metodi di cottura AMC”.

2.4.6 Selezione del programma di cottura

- ➔ Premendo il tasto intermedio è possibile selezionare i programmi di cottura.

Esempio: Audiotherm posizionato su Visiotherm.

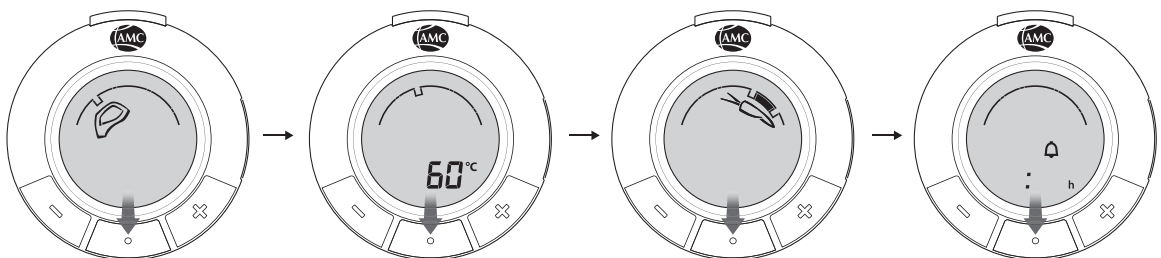

I programmi possono essere selezionati prima o dopo aver posizionato Audiotherm su Visiotherm.

2.4.7 Disattivazione del segnale acustico

- ➔ Premere un tasto qualsiasi.
In caso contrario, il segnale acustico si disattiva dopo 1 minuto.

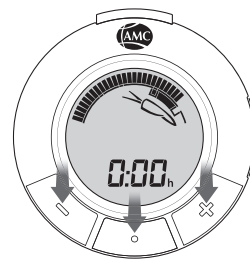

2.4.8 Rimozione di Audiotherm da Visiotherm

- ➔ Premere il tasto di sblocco e rimuovere Audiotherm.

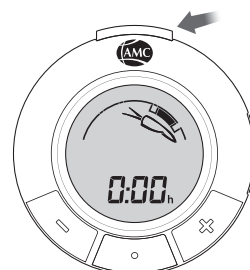

2.4.9 Spegnimento di Audiotherm

- ➔ Tenere premuto il tasto intermedio per ca. 2 secondi.

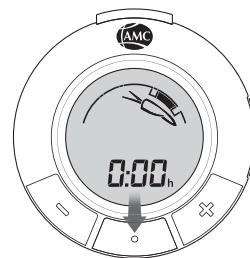

Al termine dell'utilizzo rimuovere sempre Audiotherm da Visiotherm, non immergerlo mai in acqua e non lavarlo in lavastoviglie.

2.5 Funzioni aggiuntive

2.5.1 Modifica del suono

- ➔ Accendere.
- ➔ Premere contemporaneamente il tasto + e il tasto intermedio.
- È possibile scegliere tra una melodia (S: 1) o un bip (S: 2).

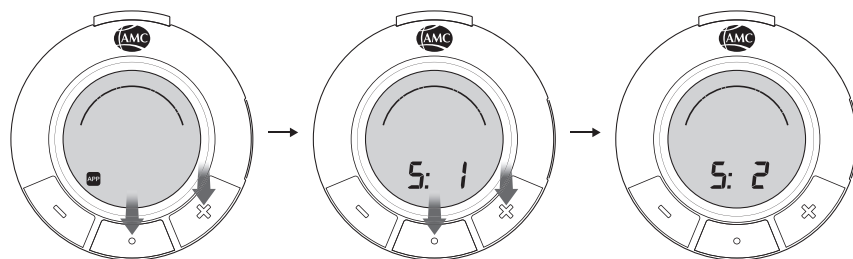

2.5.2 Modulo per persone con disabilità visive

Audiotherm dispone di modulo per persone con disabilità visive (S: 0), che può essere attivato tramite l'app Audiotherm. In questo modulo viene riprodotta una diversa sequenza di suoni per ogni programma di cottura selezionato. Inoltre, il segnale per "Aumentare livello" (+) "Diminuire livello" (-) sono diversi tra loro. Tutti gli altri segnali corrispondono al modulo "Bip" (S: 2).

2.5.3 Visualizzazione del software e dell'hardware

➔ Premere e tenere premuti contemporaneamente il tasto  e il tasto intermedio.

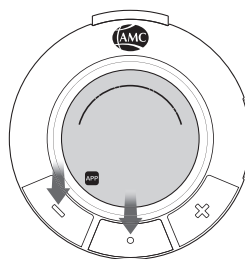

▪ Dopo una breve visualizzazione di tutti i simboli del display, apparirà il numero del software (ad es. 012) e poi quello dell'hardware (ad es. H01).

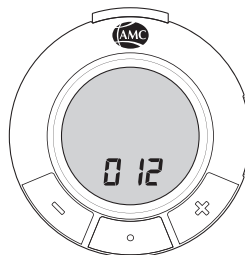

3. Che cosa fare se ...

... un programma di cottura selezionato non è disponibile sul Visiotherm utilizzato?

Al momento del posizionamento di Audiotherm viene emesso un segnale di errore e il programma di cottura precedentemente selezionato appare sul display.

➔ Controllare in quale programma si deve cucinare.

... Audiotherm impostato su un programma perde il contatto con Visiotherm?

Viene emesso un segnale di errore.

➔ Reinnestare Audiotherm correttamente in Visiotherm.

... appaiono i seguenti messaggi di errore?

E: 01
Errore nell'hardware di Audiotherm.

➔ Contattare l'Assistenza clienti.

E: 02

➔ Controllare se tutti i componenti sono posizionati correttamente e riavviare il processo di cottura.

E: 03

- ➔ Spegner Audiotherm. Rimuovere possibili fonti d'interferenza magnetica presenti nell'ambiente circostante.
- ➔ Accendere Audiotherm e riavviare il processo di cottura.
- ➔ Se l'errore dovesse ripetersi, contattare l'Assistenza clienti.

E: 04
Errore nell'hardware di Navigenio.

➔ Contattare l'Assistenza clienti.

4. Cura e manutenzione

- Pulire Audiotherm esclusivamente con un panno inumidito con un po' di acqua saponata.
- Effettuare la manutenzione e pulire Audiotherm regolarmente per garantirne la funzionalità e la sicurezza.
- Se Audiotherm dovesse cadere in acqua:
 - ➔ Spegnere immediatamente Audiotherm. Aprire il vano batterie, rimuovere le batterie e asciugare l'acqua visibile con un panno. Far asciugare Audiotherm aperto e il vano batterie per almeno 2 giorni.



5. Audiotherm e app

Audiotherm può essere gestito tramite un'app.

6. Smaltimento



L'imballaggio, Audiotherm e Visiotherm non devono essere smaltiti insieme ai rifiuti domestici. I materiali sono riciclabili. Smaltirli presso un centro di raccolta idoneo nel rispetto dell'ambiente e in conformità alle norme locali.



7. Dati tecnici

- Batterie da 1,5 V del tipo AAA/LR03/Micro (ad es. alcaline)
- Batterie ricaricabili da 1,2 V dello stesso tipo (ad es. NiMH)



8. Dichiarazione di conformità

Audiotherm soddisfa i requisiti CE in conformità alla Direttiva europea RED 2014/53/UE. Una dichiarazione di conformità completa è disponibile all'indirizzo riportato nel paragrafo "Assistenza clienti AMC".

9. Assistenza clienti AMC

In caso di domande o suggerimenti, contattare l'Assistenza clienti AMC.

Servizio clienti

AMC Italia

Alfa Metalcraft Corporation S.p.A.
Via Eugenio Curiel 242
20089 Rozzano (MI), Italia

Numero verde 800 011046

AMC Svizzera

Alfa Metalcraft AG
Buonaserstrasse 30
CH-6343 Rotkreuz

+41 (0) 41 799 51 11

Visiotherm y Audiotherm AMC

Manual de instrucciones

Contenido

1. Visiotherm	
1.1	Uso previsto y seguridad 43
1.1.1	Tapa adecuada 43
1.1.2	Seguridad 43
1.2	Estructura e indicador 43
1.3	Montaje y puesta en marcha 44
1.4	Cuidado y limpieza 44
2. Audiotherm	
2.1	Uso previsto y seguridad 44
2.2	Puesta en marcha del Audiotherm y cambio de pilas 45
2.3	Estructura y pantalla 46
2.3.1	Estructura 46
2.3.2	Pantalla 46
2.4	Funciones 47
2.4.1	Colocación sobre el Visiotherm 47
2.4.2	Encendido 47
2.4.3	Ajustar el tiempo 48
2.4.4	Gratinar y hornear con control de tiempo 49
2.4.5	Ajustar el temporizador 50
2.4.6	Seleccionar del programa de cocción 50
2.4.7	Desactivar la señal acústica 51
2.4.8	Retirar el Audiotherm del Visiotherm 51
2.4.9	Apagar el Audiotherm 51
2.5	Funciones adicionales 51
2.5.1	Modificar el sonido 51
2.5.2	Modo para personas con discapacidad visual 51
2.5.3	Mostrar el software y el hardware 52
3. Qué hacer si ...	52
4. Cuidado y limpieza	53
5. Audiotherm y App	53
6. Deshecho	53
7. Datos técnicos	53
8. Declaración de conformidad	53
9. Servicio de atención al cliente de AMC	53

Visiotherm y Audiotherm están destinados exclusivamente para uso doméstico y para el uso previsto. El uso inadecuado puede resultar peligroso.

Por favor, antes de utilizar Visiotherm y Audiotherm, leer atentamente las instrucciones de uso, especialmente las notas sobre uso adecuado y seguridad. Guardar las instrucciones de uso y entregar a los siguientes propietarios.

Leer también el folleto «Cocinar con AMC» y las correspondientes instrucciones de uso de los productos AMC utilizados.

Significado de los símbolos



Instrucciones de seguridad importantes. No cumplirlas puede provocar lesiones o daños.



Malas condiciones de funcionamiento o uso inadecuado.



Buenas condiciones de funcionamiento o uso adecuado.



Instrucciones útiles para el usuario.



Información sobre protección del medioambiente, ecología y economía.



Los pasos de procesos están resaltados con una flecha.

Versión del manual de instrucciones de Visiotherm y Audiotherm: 07/2020

1. Visiotherm

Visiotherm, en las tapas de AMC, mide la temperatura de la olla o sartén y la muestra en la pantalla. Visiotherm muestra visualmente si la temperatura en la olla o sartén es la deseada.

1.1 Uso previsto y seguridad

1.1.1 Tapa adecuada

Visiotherm es apto para todas las tapas de ollas y sartenes AMC.



1.1.2 Seguridad

- Tener en cuenta los peligros derivados del calor. Cuando la tapa está caliente, tocar sólo el Visiotherm.
- Visiotherm está equipado con un imán para transmitir la temperatura. Un marcapasos podría cambiar al modo de prueba y causar molestias si está a menos de 2 cm de la ventana de visualización del Visiotherm.
- Las tarjetas de crédito o de débito, los soportes de datos, los audífonos o los relojes mecánicos pueden verse afectados si están a menos de 2 cm de la ventana de visualización del Visiotherm.
- No utilice Visiotherm en el horno o el microondas.

1.2 Estructura e indicador

- 1 Indicador
- 2 Ventana de chuleta
- 3 Punto de volteo
- 4 Ventana de zanahoria
- 5 Rango de temperatura «zanahoria»
- 6 Ventana de parada

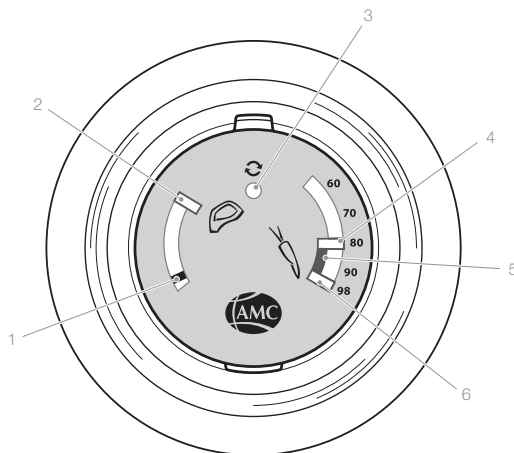

Tener en cuenta las descripciones y consejos del folleto «Cocinar con AMC».

1.3 Montaje y puesta en marcha

- ➔ Limpiar el Visiotherm con un paño húmedo antes de la primera puesta en marcha.
- ➔ Enroscar el Visiotherm en la tapa.

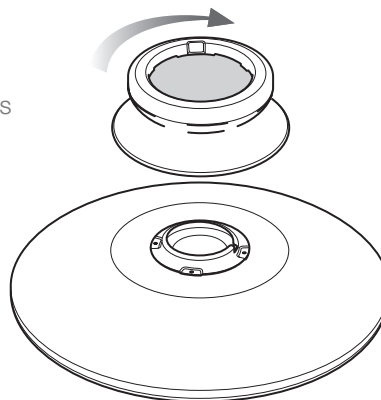

1.4 Cuidado y limpieza

- ➔ Desenroscar el Visiotherm de la tapa y limpiar ambos en el lavavajillas o a mano.
- ➔ Utilizar un detergente de uso doméstico para el lavavajillas.
- ➔ En caso de limpieza a mano, utilizar una bayeta o estropajo suave, así como un detergente neutro.



2. Audiotherm

2.1 Uso previsto y seguridad

Junto con el Visiotherm, el Audiotherm controla el proceso de cocción. Audiotherm muestra la temperatura de la olla medida por el Visiotherm y sirve de control acústico de la temperatura y del tiempo de cocción, así como para el manejo de la cocción controlada con Navigenio.

Tapa adecuada

- Tapa con Visiotherm
- Tapa de cocción al vapor EasyQuick (Súper-Vapor) con Visiotherm E
- Tapa de cocción rápida «Secuquick softline» con Visiotherm S



Evitar daños y uso indebido.

- No utilizar Visiotherm en el horno o el microondas ni someter a temperaturas superiores a 70 °C.
- No sumergir nunca el Audiotherm en agua ni lavarlo en el lavavajillas.
- Audiotherm se utiliza para controlar o manejar el proceso de cocción. Utilizar el Audiotherm para este propósito. El uso inadecuado puede resultar peligroso.
- Audiotherm contiene pilas. No se debe permitir que las pilas caigan en manos de los niños, ya que existe peligro de asfixia.
- Utilizar únicamente pilas del tipo recomendado y equivalentes (según el capítulo 5).
- No intentar cargar las pilas que no sean recargables.

Tener en cuenta también las instrucciones de uso de EasyQuick (Tapa Súper-Vapor), Secuquick softline (Tapa Rápida) y Navigenio, así como las indicaciones y consejos del folleto «Cocinar con AMC».



Supervisión

- El proceso de cocción debe supervisarse. Para controlar el proceso de cocción acústicamente, utilizar Audiotherm únicamente cuando esté al alcance del oído.
- Cocinar de forma desatendida y sin control puede llevar a un sobrecalentamiento. La comida se puede estropear y la olla puede dañarse o destruirse. Riesgo de accidentes e incendios.
- El dispositivo puede ser utilizado por niños a partir de los 8 años, personas con capacidades físicas, sensoriales o mentales limitadas o con falta de experiencia o conocimientos. Sin embargo, deben ser supervisados o instruidos en el uso seguro del dispositivo y deben haber comprendido los riesgos resultantes. Esto incluye también el control acústico por parte de personas con discapacidad visual (véase el capítulo 2.5.2).

2.2 Puesta en marcha del Audiotherm y cambio de pilas

Puesta en marcha:

En el pedido de Audiotherm se incluyen dos pilas (tipo según el capítulo 5).

Colocar las pilas para ponerlo en marcha.

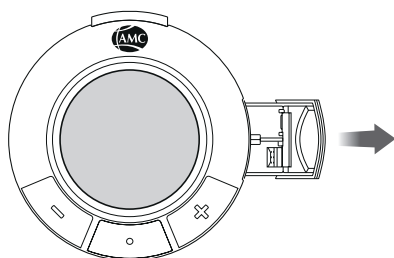

➔ Abrir el compartimento de las pilas y extraer el soporte.

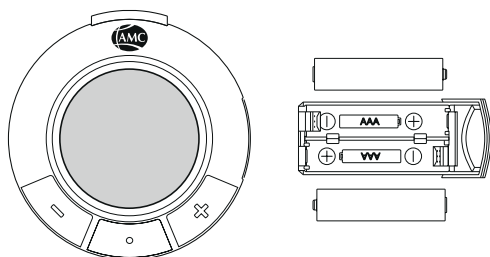

➔ Colocar las pilas según el dibujo.

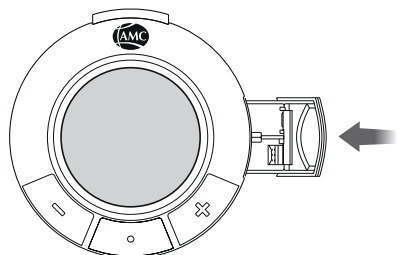

➔ Colocar el soporte de las pilas en el Audiotherm y cerrar con un «clic».

Cambio de las pilas:

Si la pantalla muestra el indicador de las pilas, estas deberán cambiarse lo antes posible.



¡Eliminar las pilas gastadas de acuerdo con la normativa local!

2.3 Estructura y pantalla

2.3.1 Estructura

- 1 Botón de desbloqueo
- 2 Botón **-**
- 3 Botón central
- 4 Botón **+**

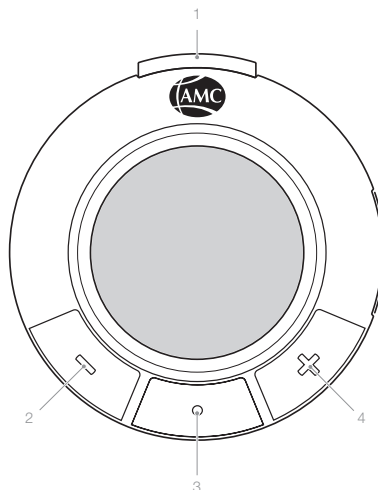

2.3.2. Pantalla

- 1 Símbolo Soft
- 2 Símbolo Asar
- 3 Símbolo Cocer
- 4 Línea de orientación
- 5 Símbolo «Punto de volteo»
- 6 Punto de volteo
- 7 Símbolo Vapor
- 8 Símbolo 60 °C
- 9 Indicador menos

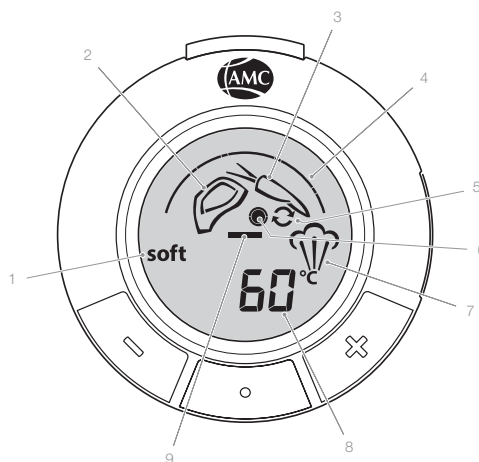

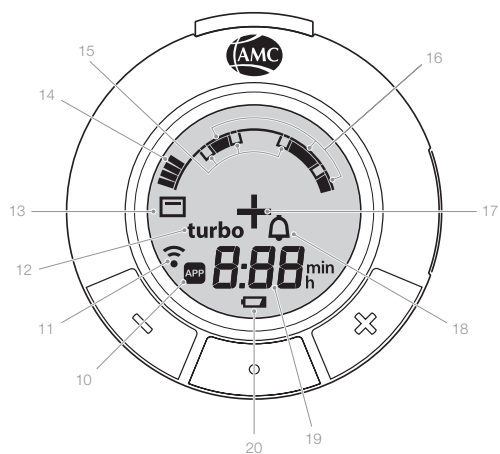

- 10 Conexión «App»
- 11 Conexión «Navegatio»
- 12 Símbolo Turbo
- 13 Símbolo Hornear
- 14 Escala de temperatura
- 15 Puntos de acción
- 16 Rango de temperatura
- 17 Indicador más
- 18 Símbolo Temporizador
- 19 Indicador del tiempo
- 20 Indicador de las pilas



2.4 Funciones

El sistema de Cocción AMC incluye diferentes métodos de cocción. El Audiotherm puede utilizarse de dos formas diferentes.

Cocción manual con Visiotherm y Audiotherm:

- Audiotherm indica la temperatura actual y avisa mediante señales  acústicas cada vez que debe intervenir. Muestra en la pantalla qué se debe hacer.
- Audiotherm avisa mediante una señal acústica  cuando el tiempo de cocción ha transcurrido.
- El usuario es responsable del funcionamiento de la cocina.

Cocción controlada:

Al cocinar sobre la placa de cocción portátil «Navegino», el Audiotherm permite cocinar de manera controlada.

- Audiotherm controla automáticamente todo el proceso de cocción a través de un enlace de radio con Navegino.
- Después de encender el Navegino en «A», el Audiotherm asume la operación del Navegino.
- Audiotherm avisa mediante una señal acústica  cuando ha transcurrido el tiempo de cocción introducido .



Todas las funciones de cocción (excepto: cocción planificada y programa 60 °C) pueden llevarse a cabo tanto manualmente como de manera controlada.

Tener en cuenta las descripciones y consejos de los «Métodos de cocina de AMC».

2.4.1 Colocación sobre el Visiotherm

- ➔ Colocar el Audiotherm sobre el Visiotherm con el pulsador hacia arriba y encajar con un «clic».

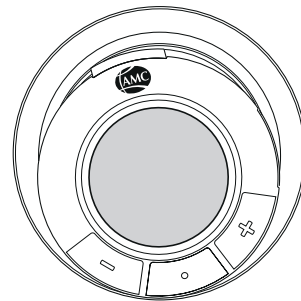

2.4.2 Encendido

- ➔ Pulsar cualquier botón.

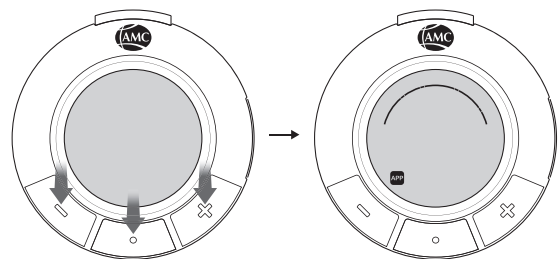

2.4.3 Ajustar el tiempo



Los tiempos pueden ajustarse antes o después de colocar el Audiotherm sobre el Visiotherm y antes o después de seleccionar el programa de cocción correspondiente. Todos los tiempos que se muestran al pulsar el botón por primera vez son valores preajustados para facilitar la entrada.

Tiempo de cocción

El tiempo de cocción puede introducirse en el Audiotherm para controlarlo. El tiempo de cocción ajustado se pone en marcha en cuanto se haya alcanzado la temperatura de cocción correspondiente.

➔ Encender.

➔ Pulsar el botón **+** para seleccionar un tiempo corto (0:10) o aumentar el tiempo de cocción deseado (mantener pulsado para un avance rápido),

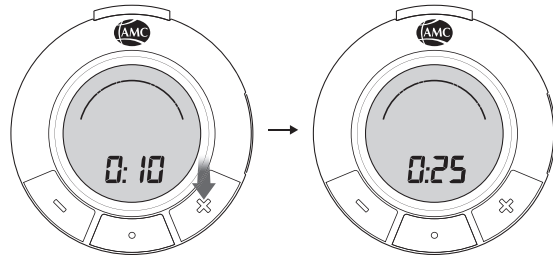

o

➔ Pulsar el botón **-** para seleccionar un tiempo largo (1:00) o reducir el tiempo de cocción deseado (mantener pulsado para un avance rápido).

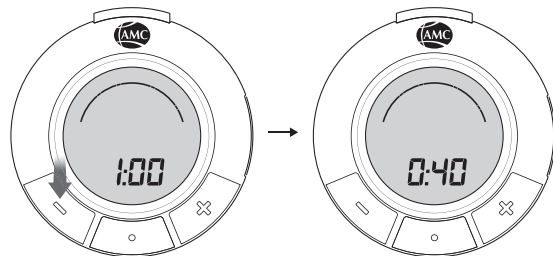

Ajuste del tiempo «P»

➔ Tras el encendido, pulsar el botón **-** y, a continuación, el botón **+**.

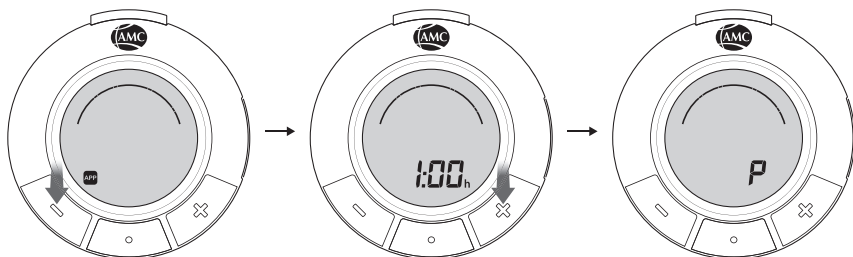

Si no se introduce ningún tiempo, el Audiotherm controla la temperatura para el proceso de cocción deseado sin limitación del tiempo. El tiempo de cocción puede ajustarse también después de que la cocción haya comenzado y modificarse durante toda la duración de la misma.

Tener en cuenta las descripciones y consejos de los «Métodos de cocina de AMC».

Cocción planificada «+»

En el modo cocción controlada con Navigenio en el nivel «A», Audiotherm puede ajustarse de modo que el proceso de cocción pueda iniciarse en un momento posterior (retraso del inicio).

➔ Encender e introducir el tiempo de cocción.

▪ En cuanto se muestre «+» en la pantalla.

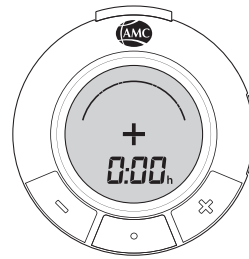

➔ Pulsar el botón + para seleccionar un tiempo de retraso del inicio corto (1:00) o aumentar el tiempo deseado (mantener pulsado para un avance rápido),

o

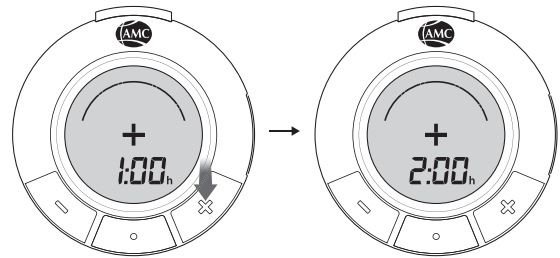

➔ Pulsar el botón - para seleccionar un tiempo de retraso del inicio largo (8:00) o reducir el tiempo de cocción deseado (mantener pulsado para un avance rápido).

▪ En la pantalla se muestran alternativamente el tiempo de cocción y el tiempo de retraso del inicio con «+».

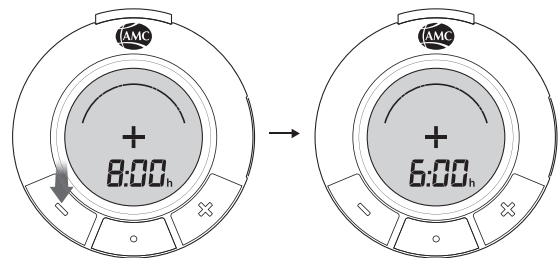

El tiempo de retraso del inicio puede modificarse durante toda la duración del proceso. La modificación del tiempo de retraso del inicio y del tiempo de cocción puede llevarse siempre a cabo si estos se muestran en la pantalla.

Tenga en cuenta las descripciones y consejos de los «Métodos de cocina de AMC».

2.4.4 Gratinar y hornear con control de tiempo

El tiempo puede introducirse en el Audiotherm para controlarlo. El tiempo puede introducirse mientras parpadee en azul/rojo en el Navigenio encendido en el nivel deseado.

➔ Pulsar el botón central hasta que se muestre el símbolo Hornear.

➔ Pulsar el botón + para aumentar el tiempo deseado (mantener pulsado para un avance rápido).

➔ Pulsar el botón - para reducir el tiempo deseado (mantener pulsado para un avance rápido).

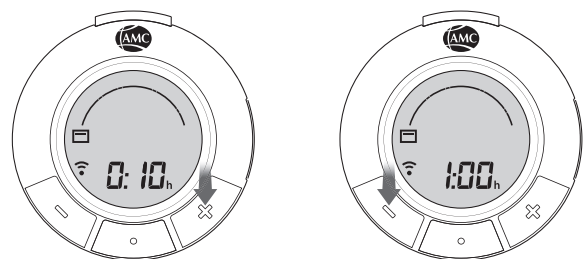

2.4.5 Ajustar el temporizador

- ➔ Encender y pulsar el botón central.

Ejemplo: Audiotherm no colocado.

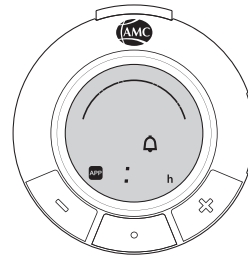

- ➔ Pulsar el botón + para aumentar el tiempo deseado (mantener pulsado para un avance rápido),

o

- ➔ Pulsar el botón - para reducir el tiempo deseado (mantener pulsado para un avance rápido).

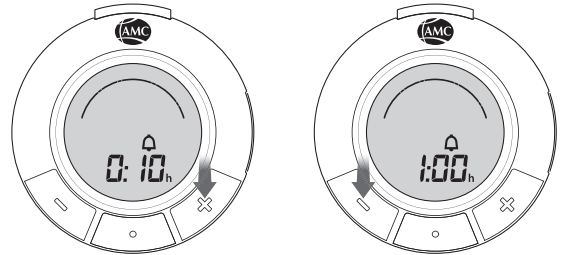

Tener en cuenta las descripciones y consejos de los «Métodos de cocina de AMC».

2.4.6 Seleccionar los programas de cocción

- ➔ Pulsando el botón central pueden seleccionarse los programas de cocción.

Ejemplo: Audiotherm colocado sobre el Visiotherm.

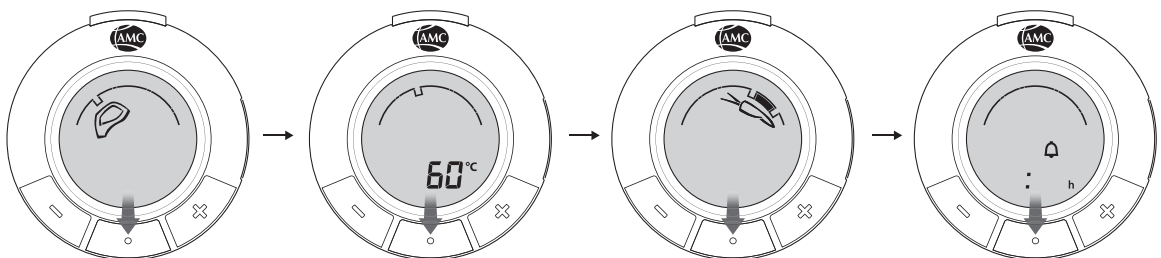

Los programas pueden seleccionarse antes o después de colocar el Audiotherm sobre el Visiotherm.

2.4.7 Desactivar la señal acústica

- ➔ Pulsar cualquier botón.
De lo contrario, la señal acústica se desconecta tras 1 minuto.

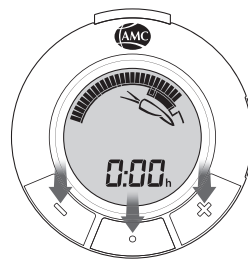

2.4.8 Retirar el Audiotherm del Visiotherm

- ➔ Pulsar el botón de desbloqueo y retirar el Audiotherm.

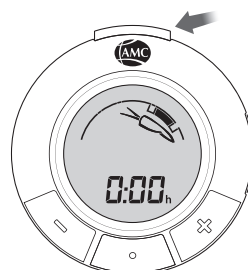

2.4.9 Apagar el Audiotherm

- ➔ Mantener pulsado el botón central durante aprox. 2 segundos.

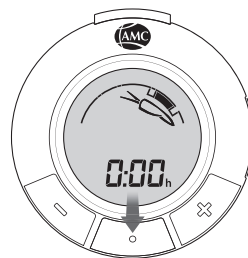

Después de cada uso, retirar siempre el Audiotherm del Visiotherm y nunca sumergirlo en agua ni introducirlo en el lavavajillas.

2.5 Funciones adicionales

2.5.1 Modificar el sonido

- ➔ Encender.
- ➔ Pulsar el botón **+** y el botón central al mismo tiempo.
- Se podrá seleccionar la melodía (S: 1) o el pitido (S: 2).

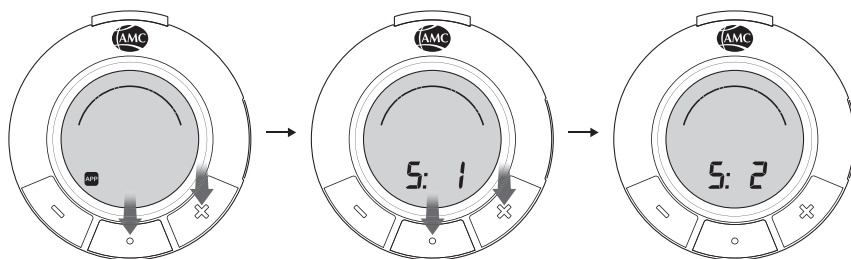

2.5.2 Modo para personas con discapacidad visual

Audiotherm dispone de un modo para personas con discapacidad visual (S: 0). Este puede desactivarse con la aplicación Audiotherm. En este modo, al seleccionar el programa de cocción se reproduce una secuencia de sonidos diferente para cada programa de cocción. Además, la señal para «Aumentar nivel» (**+**) y «Reducir nivel» (**-**) es diferente. El resto de señales corresponden al modo «pitido» (S: 2).

2.5.3 Mostrar el software y el hardware

➔ Pulsar y mantener pulsados el botón **+** y el botón central al mismo tiempo.

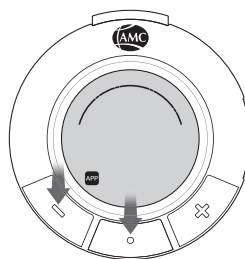

- Tras una breve indicación de todos los símbolos de la pantalla aparece el número de software (p. ej., 012) y, a continuación, el del hardware (p. ej., H01).

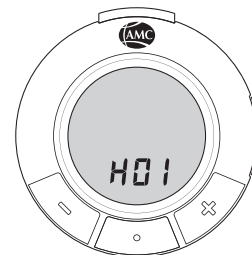
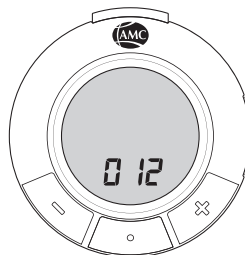

3. Qué hacer si ...

... se selecciona un programa de cocción que no está disponible en el Visiotherm utilizado

Al colocar el Audiotherm, se emite una señal de error y el programa de cocción previamente seleccionado desaparece de la pantalla.

➔ Comprobar en qué programa debería cocinarse.

... el Audiotherm ajustado en un programa pierde el contacto con el Visiotherm

Se emite una señal de error.

➔ Volver a colocar el Audiotherm correctamente en el Visiotherm.

... se muestran los siguientes mensajes de error

E: 01

Error en el hardware del Audiotherm.

➔ Ponerse en contacto con el servicio de atención al cliente.

E: 02

➔ Comprobar si todos los componentes están bien colocados y reiniciar el proceso de cocción.

E: 03

- ➔ Apagar el Audiotherm. Retirar las posibles fuentes de interferencias magnéticas de alrededor
- ➔ Encender el Audiotherm y reiniciar el proceso de cocción.
- ➔ Si el error persiste, ponerse en contacto con el servicio de atención al cliente.

E: 04

Error en el hardware de Navigenio.

➔ Ponerse en contacto con el servicio de atención al cliente.

4. Cuidado y limpieza

- Limpiar el Audiotherm únicamente con un paño humedecido con un poco de agua corriente.
- Limpiar el Audiotherm periódicamente para garantizar su funcionalidad y seguridad.
- Si el Audiotherm cae dentro de agua:
 - ➔ Apagar el Audiotherm inmediatamente. Abrir el compartimento para las pilas, retirar las pilas y secar el agua con un paño. Dejar secar el Audiotherm y el compartimento de las pilas abiertos al menos durante 2 días.



5. Audiotherm y App

El Audiotherm puede manejarse a través de una aplicación.

6. Eliminación



El embalaje, el Audiotherm y el Visiotherm no se consideran residuos domésticos. Los materiales son reutilizables. Elimínelos de forma respetuosa con el medioambiente y de acuerdo con la normativa local en puntos de recogida adecuados.



7. Datos técnicos

- Pilas de 1,5 V de tamaño AAA/LR03/Micro (p. ej., pilas alcalinas)
- Pilas recargables de 1,2 V del mismo tamaño (p. ej., NiMH)



8. Declaración de conformidad

El Audiotherm cumple los requisitos de la UE según la Directiva Europea de Equipos de Radio 2014/53/UE. Se podrá solicitar una declaración de conformidad completa en la dirección indicada en la sección «Servicio de atención al cliente de AMC».

9. Servicio de atención al cliente de AMC

En caso de preguntas o sugerencias, ponerse en contacto con el servicio de atención al cliente AMC.

Servicio de atención al cliente

AMC España

Avenida Alcalde Barnils 64 68 Bloq. A Pta. 1ª
08174 Sant Cugat del Vallés
España
Teléfono: +34-93 653 53 70

Visiotherm & Audiotherm AMC

Notice d'utilisation

Contenu

1. Visiotherm	
1.1 Utilisation conforme à l'usage prévu et la sécurité	56
1.1.1 Couvercles adaptés	56
1.1.2 Sécurité	56
1.2 Installation et affichage	56
1.3 Montage et mise en service	56
1.4 Nettoyage et maintenance	57
2. Audiotherm	
2.1 Utilisation conforme à l'usage prévu et la sécurité	57
2.2 Mise en service de l'Audiotherm et remplacement des piles	58
2.3 Installation et affichage	59
2.3.1 Installation	59
2.3.2 Affichage	59
2.4 Fonctions	60
2.4.1 Mise en place sur le Visiotherm	60
2.4.2 Allumer	60
2.4.3 Régler la durée	61
2.4.4 Gratiner ou cuire avec contrôle de la durée	62
2.4.5 Régler la minuterie	63
2.4.6 Sélectionner le programme de cuisson	63
2.4.7 Désactiver le signal sonore	64
2.4.8 Retirer l'Audiotherm du Visiotherm	64
2.4.9 Éteindre l'Audiotherm	64
2.5 Fonctions supplémentaires	64
2.5.1 Modifier la tonalité	64
2.5.2 Mode pour les personnes souffrant de déficience visuelle	64
2.5.3 Afficher le logiciel et le matériel	65
3. Que faire, si ...	65
4. Nettoyage et maintenance	66
5. Audiotherm et l'appli	66
6. Élimination	66
7. Données techniques	66
8. Déclaration de conformité	66
9. Service client AMC	66

Le Visiotherm et l'Audiotherm sont uniquement destinés à un usage domestique habituel et conforme à l'usage prévu. Une utilisation non conforme peut entraîner des dangers.

Veuillez lire attentivement le mode d'emploi – en particulier les informations sur l'utilisation conforme à l'usage prévu et à la sécurité – avant d'utiliser le Visiotherm et l'Audiotherm. Veuillez conserver le mode d'emploi et le transmettre à tout nouveau propriétaire.

Veuillez également lire la brochure « Cuisiner avec AMC » et les instructions portant sur l'utilisation des produits AMC utilisés conjointement.

Signification des symboles



Consignes de sécurité importantes. Le non-respect des consignes peut causer des blessures ou des dommages.



Mauvais état de fonctionnement ou utilisation non conforme.



Bon état de fonctionnement ou utilisation conforme.



Conseils pratiques d'utilisation.



Informations sur la protection de l'environnement, l'écologie et l'économie.



Les étapes de travail sont mises en évidence par une flèche.

Version du mode d'emploi pour le Visiotherm et l'Audiotherm : 07/2020

1. Visiotherm

Le Visiotherm posé sur les couvercles AMC mesure la température à l'intérieur des poêles et casseroles et l'affiche à l'écran. Le Visiotherm affiche donc de façon visuelle si la température souhaitée est atteinte dans la casserole ou la poêle.

1.1 Utilisation conforme à l'usage prévu et sécurité

1.1.1 Couvercles adaptés

Le Visiotherm s'adapte à toutes les poêles et casseroles AMC.



1.1.2 Sécurité

- Tenir compte des risques liés à la chaleur, toucher uniquement les couvercles chauds par le Visiotherm.
- Le Visiotherm est équipé d'un aimant pour la transmission de la température. Un stimulateur cardiaque peut être enclenché en mode essai et causer un malaise s'il se trouve à moins de 2 cm du hublot du Visiotherm.
- Les cartes bancaires, supports de données, appareils auditifs ou montres mécaniques peuvent présenter des dysfonctionnements s'ils se trouvent à moins de 2 cm du hublot du Visiotherm
- Ne pas utiliser le Visiotherm dans un four ou un micro-ondes.

1.2 Installation et affichage

- | | |
|---|----------------------------------|
| 1 | Aiguille |
| 2 | Fenêtre Viandes |
| 3 | Point de retournement |
| 4 | Fenêtre Légumes |
| 5 | Plage de température « Légumes » |
| 6 | Fenêtre Arrêt |

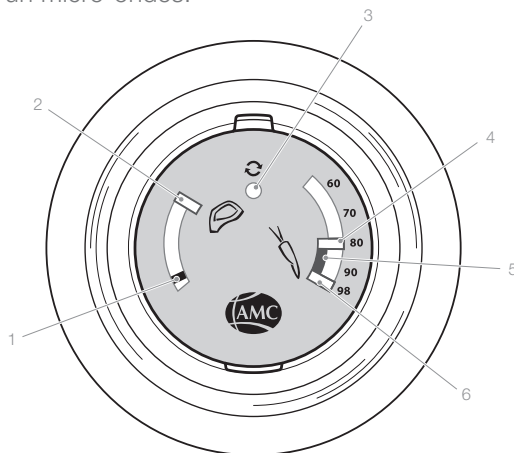

Tenir compte des descriptions et des conseils que vous trouverez dans la brochure « Cuisiner avec AMC ».

1.3 Montage et mise en service

- ➡ Essuyer le Visiotherm avec un chiffon humide avant la première mise en service.
- ➡ Visser le Visiotherm sur le couvercle.

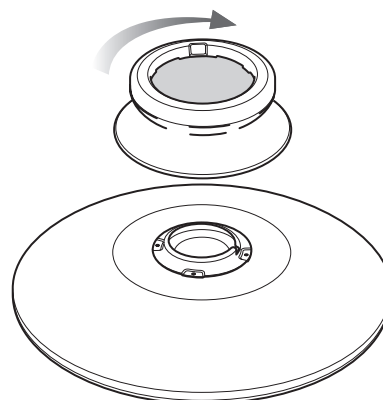

1.4 Nettoyage et maintenance

- ➔ Dévisser le Visiotherm du couvercle et nettoyer au lave-vaisselle ou à la main.
- ➔ Utiliser des produits habituels pour lave-vaisselle.
- ➔ Pour le lavage à la main, utiliser une lavette ou une éponge douce ainsi que du produit vaisselle neutre.



2. Audiotherm

2.1 Utilisation conforme à l'usage prévu et sécurité

L'Audiotherm et le Visiotherm surveillent ensemble le processus de cuisson. L'Audiotherm affiche la température mesurée par le Visiotherm dans la casserole et sert à contrôler le temps de cuisson et la température à l'aide d'un signal sonore ainsi qu'à gérer la cuisson contrôlée grâce au Navigenio.

Couvercles adaptés

- Couvercle avec Visiotherm
- Couvercle vapeur EasyQuick avec le Visiotherm E
- Couvercle cuisson rapide « Secuquick softline » avec le Visiotherm S



Prévenir les dommages et les utilisations incorrectes.

- Ne pas utiliser l'Audiotherm dans un four ou un micro-ondes et ne pas exposer à des températures supérieures à 70 °C.
- Ne jamais mettre l'Audiotherm dans l'eau et ne pas le mettre au lave-vaisselle.
- L'Audiotherm sert à surveiller ou à gérer le processus de cuisson. L'Audiotherm ne doit être utilisé qu'à cette fin. Une utilisation non conforme peut entraîner des dangers.
- L'Audiotherm contient des piles. Les piles doivent être tenues hors de portée des enfants car ils pourraient les ingérer.
- Utiliser uniquement les piles recommandées et de même type (conformément au chapitre 5).
- Ne pas essayer de recharger des piles non rechargeables.

Tenir également compte des modes d'emploi de l'EasyQuick, du Secuquick softline et du Navigenio ainsi que des remarques et conseils que vous trouverez dans la brochure « Cuisiner avec AMC ».



Surveillance

- Le processus de cuisson doit être surveillé. Utiliser l'Audiotherm pour la surveillance acoustique du processus de cuisson uniquement à portée de voix. Vous devez à tout moment pouvoir entendre votre Audiotherm.
- Une cuisson sans surveillance et sans contrôle peut entraîner une surchauffe. Cela peut détériorer les aliments et endommager ou détruire la casserole ou risque d'accident et d'incendie.
- L'appareil peut être utilisé par des enfants à partir de 8 ans ou des personnes ayant des capacités physiques, sensorielles ou mentales réduites ou manquant d'expérience ou de connaissances. Elles doivent cependant être supervisées ou formées à l'utilisation sûre de l'appareil et avoir compris les dangers qui en résultent. Cela concerne également la surveillance acoustique pour les personnes souffrant d'une déficience visuelle (voir chapitre 2.5.2).

2.2 Mise en service de l'Audiotherm et remplacement des piles

Mise en service :

Deux piles sont comprises dans la livraison de l'Audiotherm (Type conforme au chapitre 5). Insérer les piles pour la mise en service.

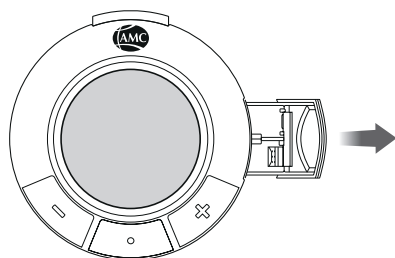

➔ Ouvrir le compartiment à piles et retirer le support des piles.

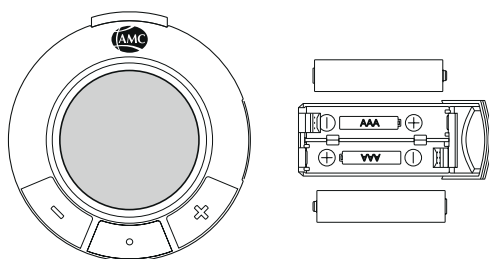

➔ Insérer les piles correctement comme illustré.

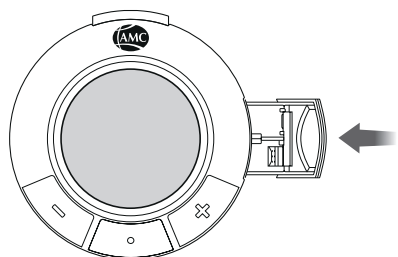

➔ Insérer le support des piles dans l'Audiotherm et refermer en un « clic ».

Remplacement des piles :

Si l'indicateur de piles apparaît sur l'écran, procéder rapidement au remplacement des piles.



Veiller à éliminer les piles usagées conformément aux réglementations locales !

2.3 Installation et affichage

2.3.1 Installation

- 1 Touche de déverrouillage
- 2 Touche **-**
- 3 Touche du milieu
- 4 Touche **+**

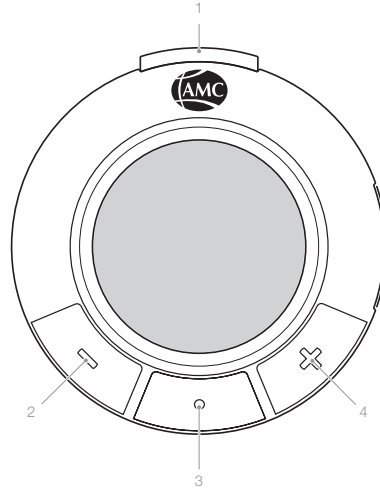

2.3.2. Affichage

- 1 Symbole Soft
- 2 Symbole Gril
- 3 Symbole Légumes
- 4 Gamme de base
- 5 Symbole « Point de retournement »
- 6 Point de retournement
- 7 Symbole Vapeur
- 8 Symbole 60 °C
- 9 Affichage moins

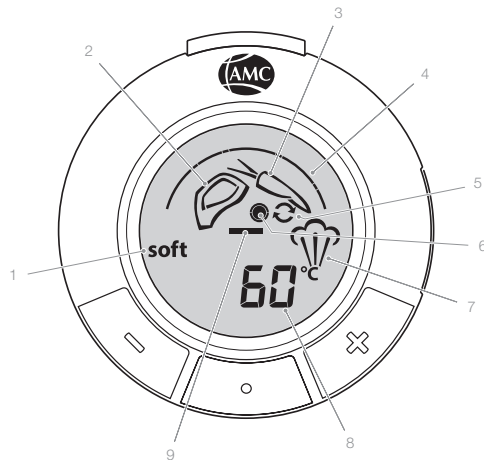

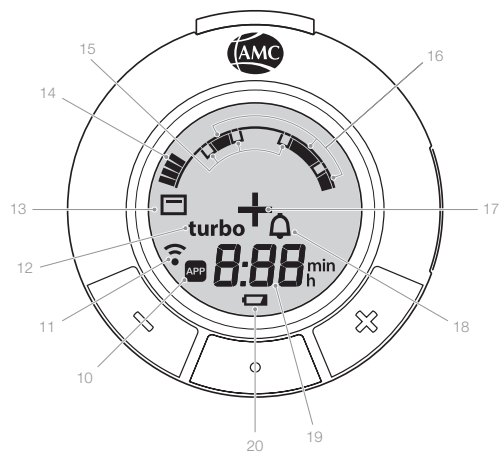

- 10 Connexion « Appli »
- 11 Connexion « Navigenio »
- 12 Symbole Turbo
- 13 Symbole Retour
- 14 Échelle des températures
- 15 Points d'action
- 16 Plages de température
- 17 Affichage plus
- 18 Symbole minuterie
- 19 Affichage du temps
- 20 Affichage piles



2.4 Fonctions

Le système de cuisson AMC comprend différentes méthodes de cuisson. L'Audiotherm peut être utilisé de deux façons.

Cuisson manuelle avec le Visiotherm et l'Audiotherm :

- L'Audiotherm affiche la température actuelle et avertit des actions à effectuer par le biais de signaux sonores . Il affiche ce qu'il faut faire sur l'écran.
- L'Audiotherm vous avertit par un signal sonore  que le temps de cuisson est terminé.
- C'est l'utilisateur qui gère la plaque de cuisson.

Cuisson contrôlée :

L'Audiotherm permet de contrôler la cuisson lorsque vous cuisinez sur la plaque de cuisson mobile « Navigenio ».

- L'Audiotherm contrôle de manière indépendante tout le processus de cuisson par l'intermédiaire d'une liaison radio avec Navigenio.
- Après la mise en marche du Navigenio sur la position « A », c'est l'Audiotherm qui contrôle le fonctionnement.
- L'Audiotherm vous avertit par un signal sonore  que le temps de cuisson réglé est terminé.



Toutes les fonctions de cuisson (exception : cuisson planifiée et programme 60 °C) peuvent être effectuées manuellement ou de façon contrôlée.

Veuillez tenir compte des descriptions et des conseils dans les « Méthodes de cuisson AMC ».

2.4.1 Mise en place sur le Visiotherm

- ➔ Poser l'Audiotherm sur le Visiotherm avec le bouton pression dirigé vers le haut et le laisser s'emboîter en un « clic ».

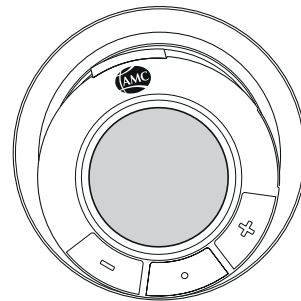

2.4.2 Allumer

- ➔ Appuyer sur n'importe quelle touche.

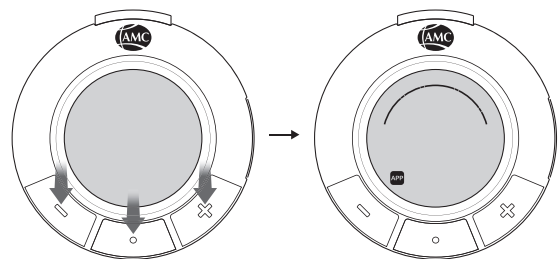

2.4.3 Régler la durée



La durée peut être réglée avant ou après avoir installé l'Audiotherm sur le Visiotherm et avant ou après avoir sélectionné le programme de cuisson. Toutes les durées qui apparaissent lorsque vous appuyez pour la première fois sur un bouton sont des valeurs préenregistrées afin de faciliter le réglage.

Temps de cuisson:

Afin de contrôler le temps de cuisson, celui-ci peut être saisi sur l'Audiotherm. Le temps de cuisson enregistré commence à s'écouler dès que la température de cuisson est atteinte.

➔ Allumer.

➔ Appuyer sur la touche **+** pour sélectionner une durée courte (0:10) ou pour augmenter le temps de cuisson souhaité (la maintenir enfoncée pour une avance rapide),

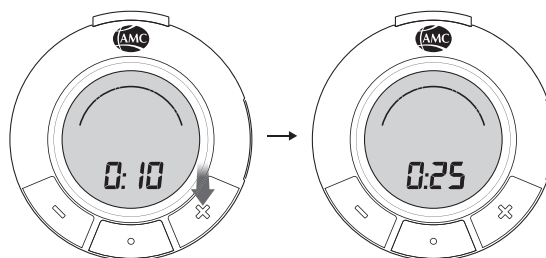

ou

➔ Appuyer sur la touche **-** pour sélectionner une durée longue (1:00) ou pour réduire le temps de cuisson souhaité (la maintenir enfoncée pour une avance rapide).

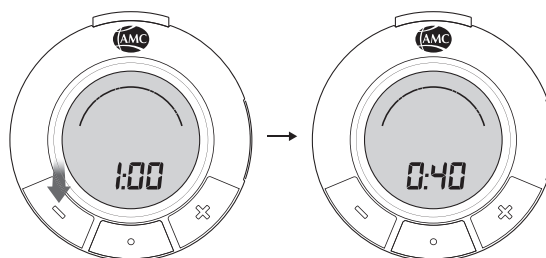

Réglage du temps « P »:

➔ Après l'avoir allumé, appuyer sur la touche **-** et ensuite sur la touche **+**.

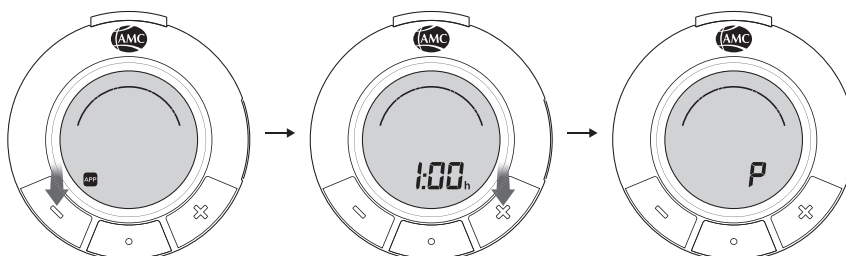

Si aucun temps de cuisson n'est saisi, l'Audiotherm contrôle la température pour le processus de cuisson souhaité sans limite de temps. Le temps de cuisson peut également être réglé après le début du processus de cuisson et être modifié pendant toute sa durée.

Veuillez tenir compte des descriptions et des conseils dans les « Méthodes de cuisson AMC ».

Cuisson planifiée « + »:

L'Audiotherm peut être réglé en fonctionnement contrôlé avec le Navigenio sur la position « A » afin que le processus de cuisson démarre à un moment ultérieur (démarrage différé).

➔ Allumer et saisir le temps de cuisson.

▪ Dès que « + » apparaît sur l'écran.

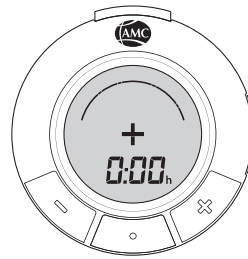

➔ Appuyer sur la touche + pour sélectionner une durée courte en mode démarrage différé (1:00) ou pour augmenter la durée souhaitée (la maintenir enfoncée pour une avance rapide),

ou

➔ Appuyer sur la touche - pour sélectionner une durée longue en mode démarrage différé (8:00) ou pour réduire la durée souhaitée (la maintenir enfoncée pour une avance rapide).

▪ Le temps de cuisson et la durée avec démarrage différé s'affichent à l'écran en alternance avec « + ».

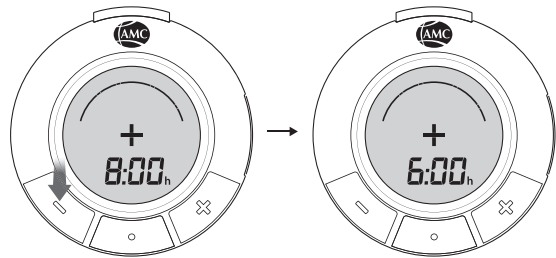
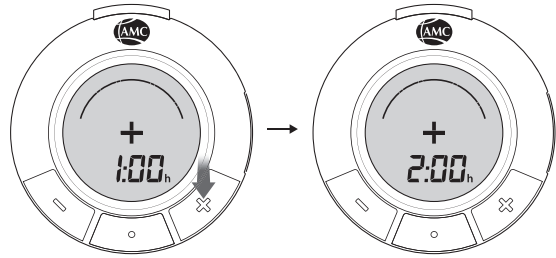

La durée avec démarrage différé saisie peut être modifiée pendant tout le temps de fonctionnement.

La durée avec démarrage différé et le temps de cuisson peuvent toujours être modifiés lorsqu'ils s'affichent sur l'écran.

Veuillez tenir compte des descriptions et des conseils dans les « Méthodes de cuisson AMC ».

2.4.4 Gratiner ou cuire avec contrôle de la durée

Afin de contrôler la durée, celle-ci peut être saisie sur l'Audiotherm. La durée peut être saisie tant que le Navigenio réglé sur la position souhaitée clignote en alternance en bleu et en rouge.

➔ Appuyer sur la touche du milieu jusqu'à ce que le symbole retour apparaisse.

➔ Appuyer sur la touche + pour augmenter la durée souhaitée (la maintenir appuyée pour une avance rapide).

➔ Appuyer sur la touche - pour réduire la durée souhaitée (la maintenir appuyée pour une avance rapide).

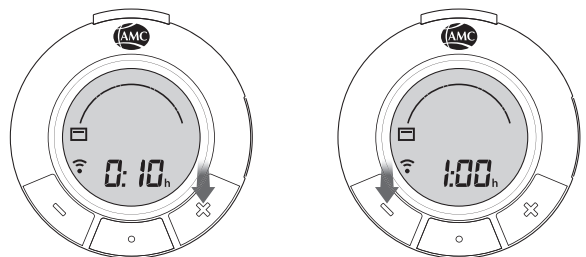

2.4.5 Régler la minuterie

- ➔ Allumer et appuyer sur la touche du milieu.

Exemple : L'Audiotherm n'est pas installé.

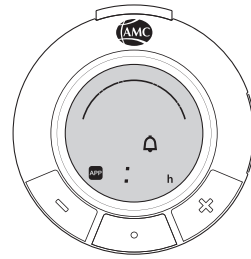

- ➔ Appuyer sur la touche + pour augmenter la durée souhaitée (la maintenir appuyée pour une avance rapide),

ou

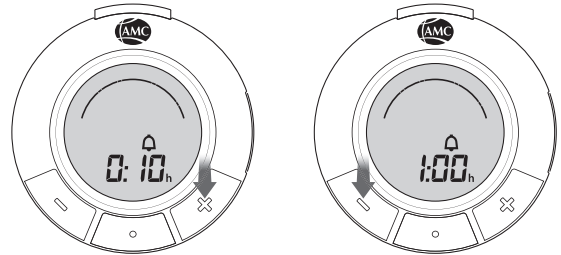

- ➔ Appuyer sur la touche - pour réduire la durée souhaitée (la maintenir appuyée pour une avance rapide)

Veuillez tenir compte des descriptions et des conseils dans les « Méthodes de cuisson AMC ».

2.4.6 Sélectionner le programme cuisson

- ➔ Les programmes de cuisson peuvent être sélectionnés en appuyant sur la touche du milieu.

Exemple : L'Audiotherm est installé sur le Visiotherm.

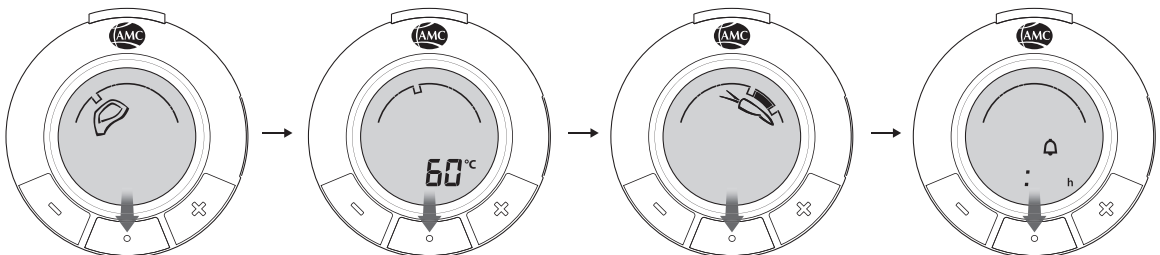

Les programmes peuvent être sélectionnés avant ou après l'installation de l'Audiotherm sur le Visiotherm.

2.4.7 Désactiver le signal sonore

- ➔ Appuyer sur n'importe quelle touche.
- Ou attendre 1 minute que le signal sonore se désactive automatiquement.

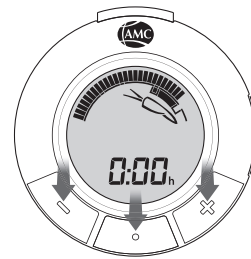

2.4.8 Retirer l'Audiotherm du Visiotherm

- ➔ Appuyer sur la touche de déverrouillage et retirer l'Audiotherm.

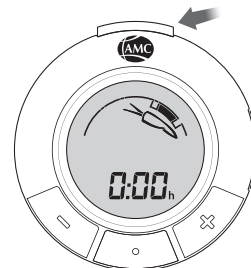

2.4.9 Éteindre l'Audiotherm

- ➔ Maintenir la touche du milieu enfoncée pendant env. 2 secondes.

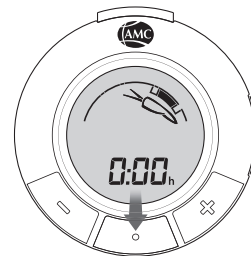

Retirer toujours l'Audiotherm du Visiotherm après utilisation et ne jamais le mettre dans l'eau ni le passer au lave-vaisselle.

2.5 Fonctions supplémentaires

2.5.1 Modifier la tonalité

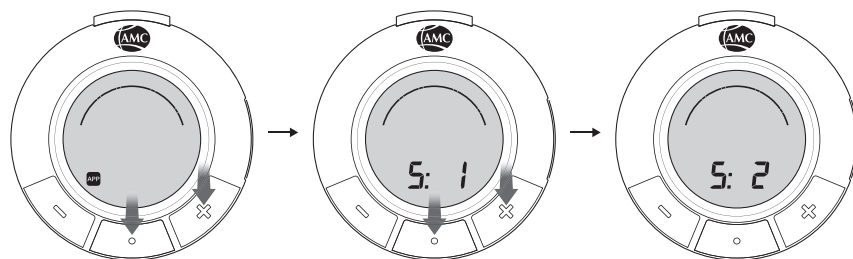

- ➔ Allumer.
- ➔ Appuyer en même temps sur la touche + et sur la touche du milieu.

- Il est possible de sélectionner la mélodie (S: 1) ou le bip (S: 2).

2.5.2 Mode pour les personnes souffrant de déficience visuelle

L'Audiotherm dispose d'un mode pour les personnes souffrant de déficience visuelle (S:0). Celui-ci peut être activé via l'appli Audiotherm. Dans ce mode, une suite de tonalités différentes pour chaque programme de cuisson est jouée lorsque ceux-ci sont sélectionnés. De plus, les signaux sonores pour « Augmenter la puissance de chauffage » (+) et « Baisser la puissance de chauffage » (-) sont (-) différents. Tous les autres signaux correspondent au mode « bip » (S: 2).

2.5.3 Afficher la version du logiciel et du matériel

➔ Appuyer simultanément sur la touche  et sur la touche du milieu et les maintenir appuyées.

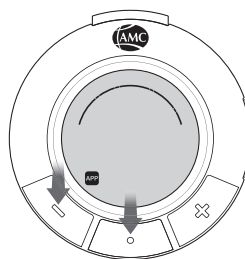

▪ Après un bref affichage de tous les symboles de l'écran, le numéro du logiciel apparaît (par ex. 012) et ensuite celui du matériel (par ex. H01).

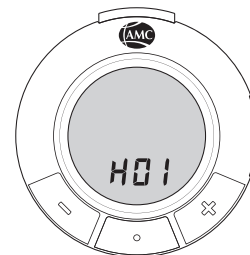
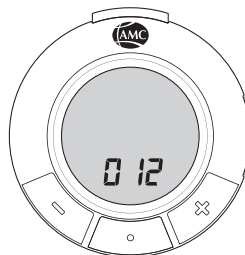

3. Que faire, si ...

... un programme de cuisson sélectionné n'est pas disponible sur le Visiotherm utilisé ?

Lorsque l'Audiotherm est installé, un signal d'erreur retentit et le programme de cuisson précédemment sélectionné disparaît de l'écran.

➔ Vérifier avec quel programme la cuisson doit être effectuée.

... l'Audiotherm réglé sur un programme perd le contact avec le Visiotherm ?

Un signal d'erreur retentit.

➔ Enclencher à nouveau l'Audiotherm correctement sur le Visiotherm.

... les messages d'erreur suivants apparaissent ?

E : 01

Erreur matérielle de l'Audiotherm.

➔ Contacter le service client.

E : 02

➔ Vérifier que tous les composants soient correctement installés, et redémarrer le processus de cuisson.

E : 03

➔ Éteindre l'Audiotherm. Retirer toute source d'interférence magnétique de l'environnement.
➔ Allumer l'Audiotherm et redémarrer le processus de cuisson.
➔ Si l'erreur se répète, contacter le service à la clientèle.

E : 04

Erreur matérielle du Navigenio.

➔ Contacter le service client.

4. Nettoyage et maintenance

- Nettoyer l'Audiotherm avec un peu d'eau savonneuse sur un chiffon humide.
- Entretien et nettoyer l'Audiotherm régulièrement, afin d'en assurer un bon fonctionnement et de garantir la sécurité.
- Si l'Audiotherm tombe dans l'eau :
 - ➔ Éteindre immédiatement l'Audiotherm. Ouvrir le compartiment à piles, retirer les piles, sécher toute l'eau que vous voyez à l'aide d'un chiffon. Laisser sécher l'Audiotherm et le compartiment à piles ouverts au moins 2 jours.



5. Audiotherm et l'appli

L'Audiotherm peut être utilisé via une Appli.

6. Élimination



L'emballage, l'Audiotherm et le Visiotherm ne doivent pas être jetés aux ordures ménagères. Les composants sont recyclables. Veiller à les amener aux points de collecte correspondants pour les éliminer de manière respectueuse de l'environnement et conformément aux réglementations locales.



7. Données techniques

- Pile 1,5 Vde taille AAA/LR03/Micro (par ex. alcaline)
- Piles rechargeables 1,2 V de même type (par ex. NiMH)



8. Déclaration de conformité

L'Audiotherm répond aux exigences CE selon la directive européenne sur les équipements radio 2014/53 /UE. Une déclaration de conformité complète peut être obtenue à l'adresse indiquée dans la section « Service client AMC » ci-dessous.

9. Service client AMC

Si vous avez des questions ou des suggestions, merci de contacter le service client AMC.

Service après-vente

AMC Belgium N.V.

Alfa Metalcraft Corp. S.A.
Kortrijksesteenweg 205 - Bus 1
9830 Sint-Martens-Latem, Belgique

+32-(0)9-2509360

AMC Suisse

Alfa Metalcraft SA
Buonaserstrasse 30
6343 Rotkreuz, Suisse

+41 (0) 41 799 51 11

AMC Visiotherm & Audiotherm

Gebruiksaanwijzing

Inhoud

1. Visiotherm	
1.1 Reglementair gebruik en veiligheid	69
1.1.1 Geschikte deksels	69
1.1.2 Veiligheid	69
1.2 Opbouw en weergave	69
1.3 Montage en ingebruikneming	69
1.4 Onderhoud en reiniging	70
2. Audiotherm	
2.1 Reglementair gebruik en veiligheid	70
2.2 Ingebruikneming van de Audiotherm en vervangen van de batterijen	71
2.3 Opbouw en display	72
2.3.1 Opbouw	72
2.3.2 Display	72
2.4 Functies	73
2.4.1 Op de Visiotherm zetten	73
2.4.2 Inschakelen	73
2.4.3 Tijd instellen	74
2.4.4 Tijd gecontroleerd gratineren en bakken	75
2.4.5 Kookwekker instellen	76
2.4.6 Kookprogramma kiezen	76
2.4.7 Geluidssignaal uitschakelen	77
2.4.8 Audiotherm van de Visiotherm afnemen	77
2.4.9 Audiotherm uitschakelen	77
2.5 Extra functies	77
2.5.1 Geluid wijzigen	77
2.5.2 Modus voor mensen met een visuele handicap	77
2.5.3 Software en hardware weergeven	78
3. Wat te doen als ...	78
4. Onderhoud en reiniging	79
5. Audiotherm en app	79
6. Afvalverwerking	79
7. Technische gegevens	79
8. Conformiteitsverklaring	79
9. AMC-klantenservice	79

De Visiotherm en de Audiotherm zijn uitsluitend bedoeld voor de gangbare huishoudelijke en reglementaire toepassingen. Bij een onjuist gebruik kunnen er gevaarlijke situaties ontstaan.

Lees de gebruiksaanwijzing, in het bijzonder het hoofdstuk met betrekking tot het reglementair gebruik en de veiligheid, aandachtig door vooraleer u de Visiotherm en de Audiotherm in gebruik neemt. Bewaar de gebruiksaanwijzing op een veilige plaats en geef ze door aan de volgende gebruiker(s).

Lees ook de brochure „Koken met AMC” en de gebruiksaanwijzingen van de andere producten van AMC die u gebruikt aandachtig door.

Betekenis van de symbolen



Instructies die belangrijk zijn voor de veiligheid. Het niet naleven ervan kan letsels of materiële schade veroorzaken.



Slechte staat of onjuist gebruik.



Goede staat of correct gebruik.



Nuttige info voor de gebruikers.



Info met betrekking tot milieubescherming, ecologie en economie.



Werkstappen worden voorafgegaan door een pijl.

Versie van de gebruiksaanwijzing voor de Visiotherm en de Audiotherm: 07/2020

1. Visiotherm

De Visiotherm op AMC-deksels meet de temperatuur in de kookpot/kookpan en pan en geeft deze weer op het display. De Visiotherm geeft zo optisch weer of in de kookpot/kookpan de gewenste temperatuur bereikt is.

1.1 Reglementair gebruik en veiligheid

1.1.1 Geschikte deksels

De Visiotherm is geschikt voor alle deksels van kookpotten/kookpannen van AMC.



1.1.2 Veiligheid

- Houd rekening met gevaren door hitte en neem hete deksels uitsluitend aan de Visiotherm vast.
- De Visiotherm is voorzien van een magneet voor het doorgeven van de temperatuur. Een pacemaker kan in de testmodus worden geschakeld en gezondheidsproblemen veroorzaken als deze zich op minder dan 2 cm afstand van het kijkvenster van de Visiotherm bevindt.
- Creditcards, EC-cards, gegevensdragers, gehoorapparaten en mechanische horloges kunnen worden beïnvloed als ze zich op minder dan 2 cm afstand van het kijkvenster van de Visiotherm bevinden
- Gebruik de Visiotherm niet in bakovens of microgolfovens.

1.2 Opbouw en weergave

- 1 Wijzer
- 2 Braadvenster
- 3 Omdraaipunt
- 4 Groentevenster
- 5 Temperatuurbereik „Groenten”
- 6 Stopvenster

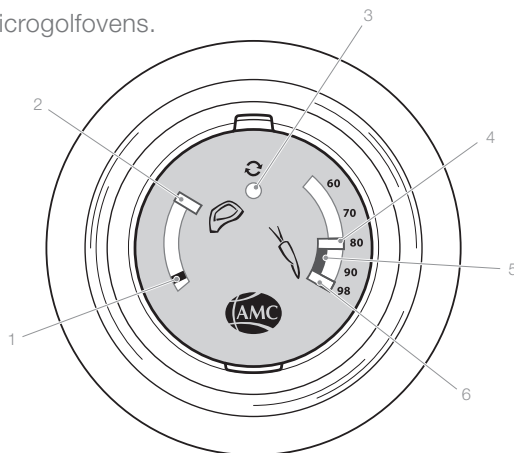

Lees de beschrijvingen en tips in de brochure „Koken met AMC”.

1.3 Montage en ingebruikneming

- ➔ Veeg de Visiotherm voor de eerste ingebruikneming schoon met een vochtige doek.
- ➔ Schroef de Visiotherm op het deksel.

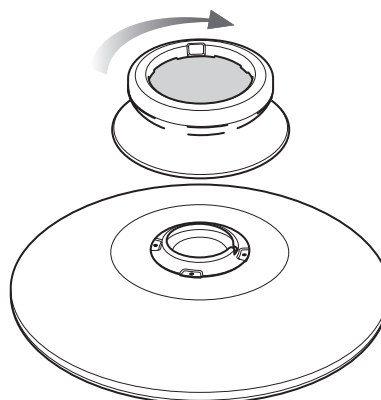

1.4 Onderhoud en reiniging

- ➔ Schroef de Visiotherm van het deksel en was beide af in de vaatwasmachine of met de hand.
- ➔ Gebruik voor de vaatwasmachine een gangbare huishoudelijke machine-reiniger.
- ➔ Gebruik bij het afwassen met de hand een vaatdoek of een zachte spons en een neutraal afwasmiddel.



2. Audiotherm

2.1 Reglementair gebruik en veiligheid

De Audiotherm controleert samen met de Visiotherm het kookproces. De Audiotherm geeft de temperatuur weer die door de Visiotherm in de kookpot/kookpan wordt gemeten en dient als akoestische temperatuur- en kooktijdcontrole en als regelaar bij het gecontroleerd koken met de Navigenio.

Geschikte deksels

- Deksel met Visiotherm
- Stoomdeksel EasyQuick met Visiotherm E
- Snelkookdeksel „Secuquick softline” met Visiotherm S



Vermijd beschadigingen en onjuist gebruik.

- Gebruik de Audiotherm niet in bakovens of microgolfovens en stel hem niet bloot aan temperaturen boven 70 °C.
- Dompel de Audiotherm nooit onder in water en stop hem niet in de vaatwasmachine.
- De Audiotherm dient om het kookproces te controleren of te regelen. Gebruik de Audiotherm alleen voor dit doel. Bij een onjuist gebruik kunnen er gevaarlijke situaties ontstaan.
- De Audiotherm bevat batterijen. Batterijen moet buiten het bereik van kinderen worden gehouden omdat ze kunnen worden ingeslikt.
- Gebruik alleen batterijen van het aanbevolen type of een gelijkwaardig type (zie hoofdstuk 5).
- Probeer niet-herlaadbare batterijen niet op te laden.

Lees ook de gebruiksaanwijzingen van de EasyQuick, Secuquick softline en Navigenio en de info en tips in de brochure „Koken met AMC”.



Toezicht

- Er moet toezicht worden gehouden op het kookproces. Gebruik voor de akoestische controle van het kookproces de Audiotherm uitsluitend binnen gehoorsafstand.
- Ongecontroleerd koken zonder toezicht kan leiden tot oververhitting. Ingrediënten kunnen bederven en de kookpot/kookpan kan beschadigd geraken of volledig stuk gaan of risico op ongevallen en brandgevaar.
- Het toestel kan worden gebruikt door kinderen vanaf 8 jaar of door personen met fysieke, zintuiglijke of geestelijke beperkingen of een gebrek aan ervaring of kennis. Er moet echter altijd iemand zijn die toezicht houdt of zij moeten worden geïnstrueerd in het veilige gebruik van het toestel en op de hoogte zijn van de gevaren die hiermee gepaard gaan. Dit geldt ook voor de akoestische controle door personen met een visuele handicap (zie hoofdstuk 2.5.2).

2.2 Ingebruikneming van de Audiotherm en vervangen van de batterijen

Ingebruikneming:

Bij de Audiotherm zijn twee batterijen inbegrepen (type zie hoofdstuk 5).
Plaats de batterijen voor de ingebruikneming.

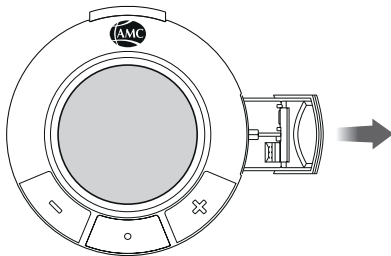

- ➔ Open het batterijvak en verwijder de batterijhouder.

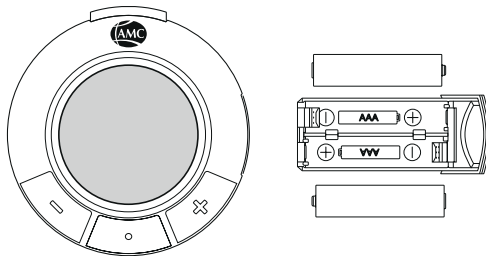

- ➔ Plaats de batterijen correct zoals weergegeven op de afbeelding.

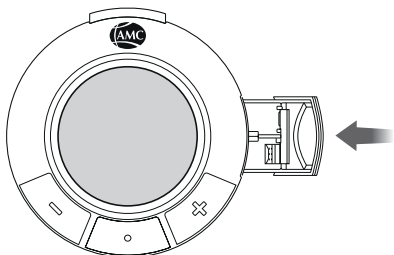

- ➔ Breng de batterijhouder aan in de Audiotherm en sluit deze met een „klik”.

Batterijen vervangen:

Als de batterijweergave zichtbaar is op het display moeten de batterijen weldra worden vervangen.



Voer lege batterijen af volgens de plaatselijke voorschriften!

2.3 Opbouw en display

2.3.1 Opbouw

- 1 Ontgrendelingstoets
- 2 —-toets
- 3 Middelste toets
- 4 +-toets

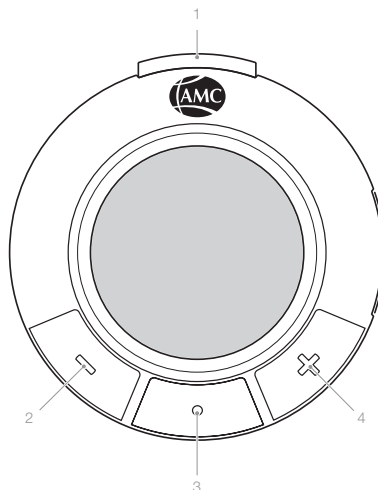

2.3.2. Display

- 1 Soft-symbool
- 2 Braadsymbool
- 3 Groentesymbool
- 4 Basislijn
- 5 Symbool „omdraaipunt”
- 6 Omdraaipunt
- 7 Stoomsymbool
- 8 60°C-symbool
- 9 Min-weergave

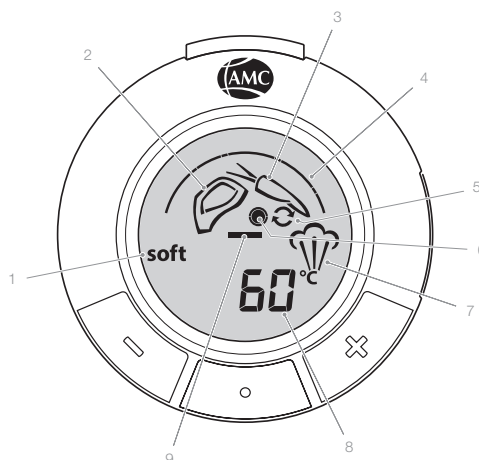

- 10 Verbinding „app”
- 11 Verbinding „Navigenio”
- 12 Turbosymbool
- 13 Baksymbool
- 14 Temperatuurverdeling
- 15 Actiepunten
- 16 Temperatuurbereiken
- 17 Plus-weergave
- 18 Kookwekkersymbool
- 19 Tijdsweergave
- 20 Batterijweergave

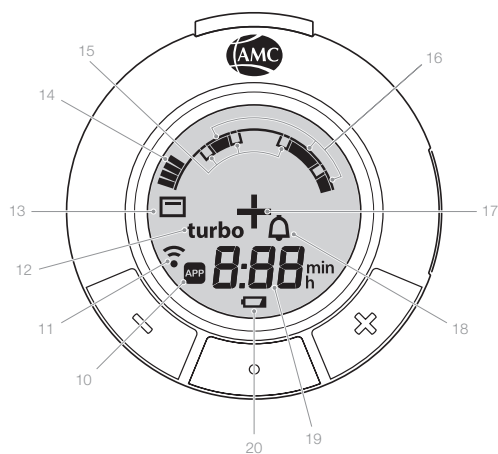

2.4 Functies

Het AMC-kookstelsel omvat verschillende kookmethoden. De Audiotherm kan daarbij op twee manieren worden gebruikt.

Handmatig koken met de Visiotherm en de Audiotherm:

- De Audiotherm geeft de actuele temperatuur weer en duidt met geluidssignalen  aan wanneer er iets moet worden gedaan. Hij geeft op het display weer wat er moet worden gedaan.
- De Audiotherm duidt met een geluidssignaal  aan dat de kooktijd verstreken is.
- Het is aan de gebruiker om de kookplaat te bedienen.

Gecontroleerd koken:

De Audiotherm maakt het mogelijk om gecontroleerd te koken bij gebruik van de mobiele kookplaat „Navigenio”.

- De Audiotherm controleert autonoom het volledige kookproces via een draadloze verbinding met de Navigenio.
- Nadat de Navigenio is ingeschakeld op „A” wordt de bediening van de Navigenio overgenomen door de Audiotherm.
- De Audiotherm duidt met een geluidssignaal  aan dat de ingevoerde kooktijd verstreken is.



Alle kookfuncties (uitzondering: gepland koken met 60°C-programma) kunnen zowel handmatig als gecontroleerd worden uitgevoerd.

Lees de beschrijvingen en tips in de „AMC-kookmethoden”.

2.4.1 Op de Visiotherm zetten

- ➔ Zet de Audiotherm met de drukknop naar boven gericht op de Visiotherm en laat hem met een „klik” vergrendelen.

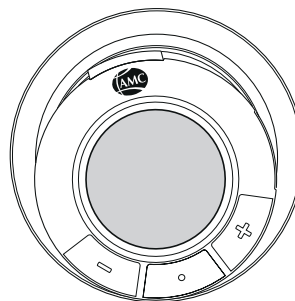

2.4.2 Inschakelen

- ➔ Druk op een willekeurige toets.

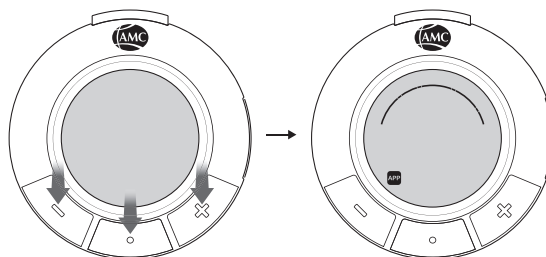

2.4.3 Tijd instellen



Tijden kunnen worden ingesteld voor of nadat de Audiotherm op de Visiotherm wordt gezet en voor of nadat het desbetreffende kookprogramma wordt geselecteerd. Alle tijden die verschijnen als de toetsen voor het eerst worden ingedrukt, zijn vooraf ingestelde waarden om het instellen gemakkelijker te maken.

Kooktijd:

Om de kooktijd te controleren, kan deze in de Audiotherm worden ingevoerd. De ingestelde kooktijd begint te lopen zodra de desbetreffende kooktemperatuur is bereikt.

➔ Inschakelen.

➔ Druk op de **+**-toets om een korte tijd (0:10) te kiezen of om de gewenste kooktijd te verhogen (ingedrukt houden voor een snelle verhoging),

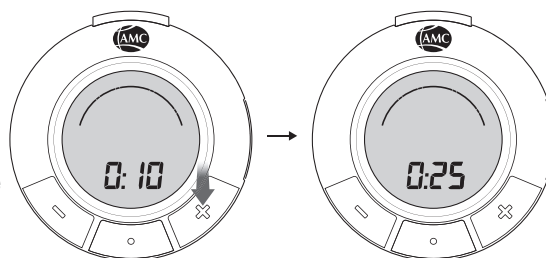

of

➔ Druk op de **-**-toets om een lange tijd (1:00) te kiezen of om de gewenste kooktijd te verlagen (ingedrukt houden voor een snelle verlaging).

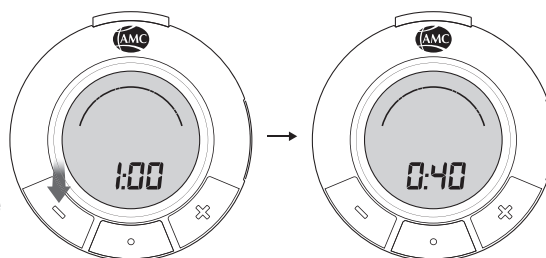

Tijdstelling „P”:

➔ Druk na het inschakelen op de **-**-toets en daarna op de **+**-toets.

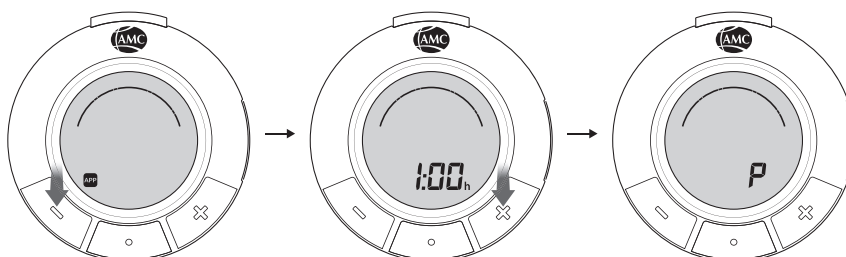

Zonder tijdsinvoer controleert de Audiotherm de temperatuur voor het gewenste kookproces zonder tijdsbegrenzing. De kooktijd kan ook na het starten van het kookproces worden ingesteld en gedurende de volledige looptijd worden gewijzigd.

Lees de beschrijvingen en tips in de „AMC-kookmethoden”.

Gepland koken „+“:

De Audiotherm kan in de gecontroleerde modus met de Navigenio in stand „A“ zo worden ingesteld dat het kookproces op een later tijdstip start (startuitletstel).

- ➔ Inschakelen en kooktijd invoeren.
- Zodra op het display „+“ verschijnt.

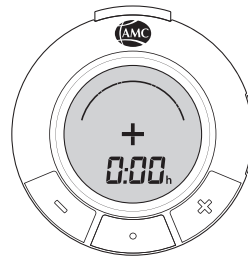

- ➔ Druk op de +-toets om een korte startuitletsteltijd (1:00) te kiezen of om de gewenste tijd te verhogen (ingedrukt houden voor een snelle verhoging),

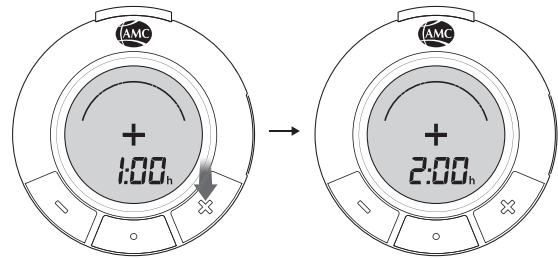

of

- ➔ Druk op de -toets om een lange startuitletsteltijd (8:00) te kiezen of om de gewenste tijd te verlagen (ingedrukt houden voor een snelle verlaging).

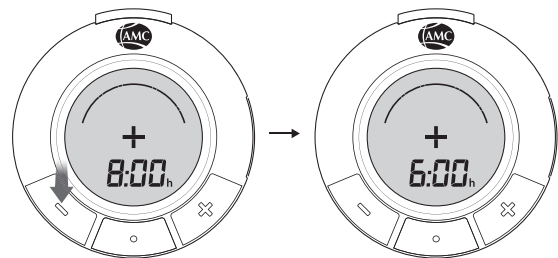

- Op het display worden afwisselend de kooktijd en de startuitletsteltijd met „+“ weergegeven.



De ingestelde startuitletsteltijd kan gedurende de volledige looptijd worden gewijzigd. De startuitletsteltijd of de kooktijd kan altijd worden gewijzigd als deze is weergegeven op het display.

Lees de beschrijvingen en tips in de „AMC-kookmethoden“.

2.4.4 Tijd gecontroleerd gratineren en bakken

Om de tijd te controleren, kan deze worden ingevoerd in de Audiotherm. De tijd kan worden ingevoerd zolang de Navigenio in de gewenste stand is ingeschakeld en afwisselend blauw/rood knippert.

- ➔ Druk op de middelste toets tot het baksymbool verschijnt.
- ➔ Druk op de +toets om de gewenste tijd te verhogen (ingedrukt houden voor een snelle verhoging).
- ➔ Druk op de -toets om de gewenste tijd te verlagen (ingedrukt houden voor een snelle verlaging).

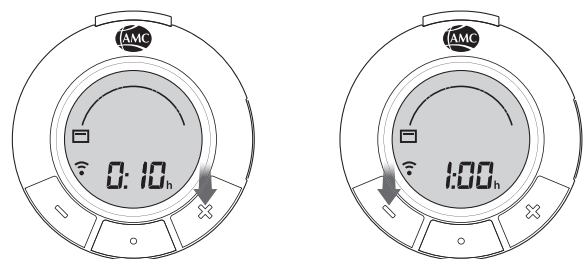

2.4.5 Kookwekker instellen

- ➔ Inschakelen en op de middelste toets drukken.

Voorbeeld: Audiotherm niet op de Visiotherm gezet.

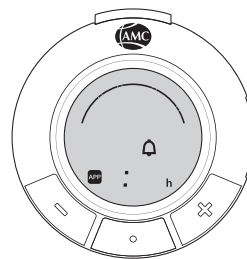

- ➔ Druk op de **+**-toets om de gewenste tijd te verhogen (ingedrukt houden voor een snelle verhoging),

of

- ➔ Druk op de **-**-toets om de gewenste tijd te verlagen (ingedrukt houden voor een snelle verlaging)

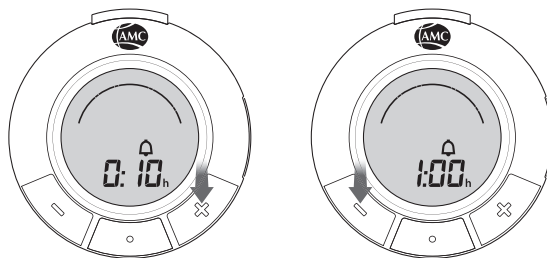

Lees de beschrijvingen en tips in de „AMC-kookmethoden”.

2.4.6 Kookprogramma's kiezen

- ➔ Door op de middelste toets te drukken, kunnen kookprogramma's worden geselecteerd.

Voorbeeld: Audiotherm op de Visiotherm gezet.

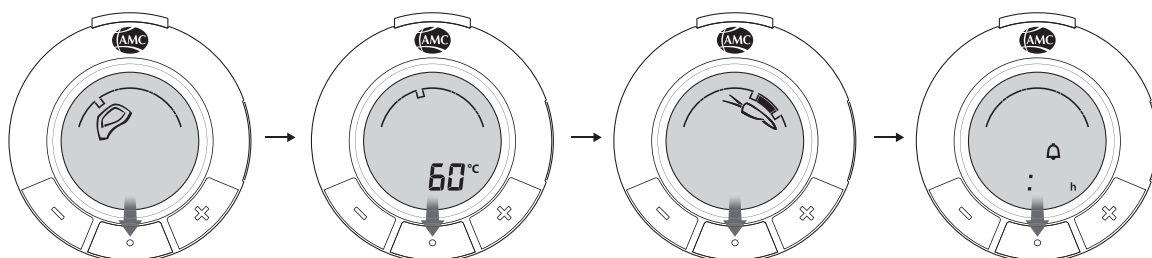

Programma's kunnen worden geselecteerd voor of nadat de Audiotherm op de Visiotherm wordt gezet.

2.4.7 Geluidssignaal uitschakelen

- ➔ Druk op een willekeurige toets.
Anders wordt het geluidssignaal na 1 minuut uitgeschakeld.

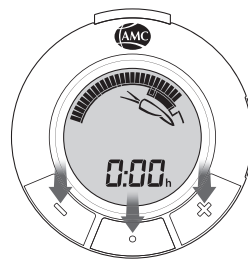

2.4.8 Audiotherm van de Visiotherm afnemen

- ➔ Druk op de ontgrendelingstoets en neem de Audiotherm eraf.

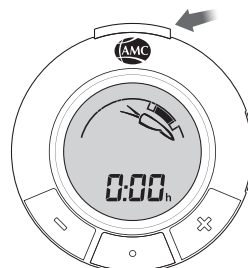

2.4.9 Audiotherm uitschakelen

- ➔ Houd de middelste toets gedurende ca. 2 seconden ingedrukt.

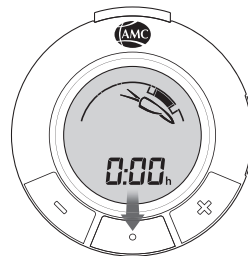

Neem de Audiotherm na gebruik altijd van de Visiotherm af en dompel hem nooit onder in water of stop hem niet in de vaatwasmachine.

2.5 Extra functies

2.5.1 Geluid wijzigen

- ➔ Inschakelen.
- ➔ Druk tegelijkertijd op de **+**-toets en de middelste toets.
- Er kan worden gekozen tussen een melodie (S: 1) of pieptoon (S: 2).

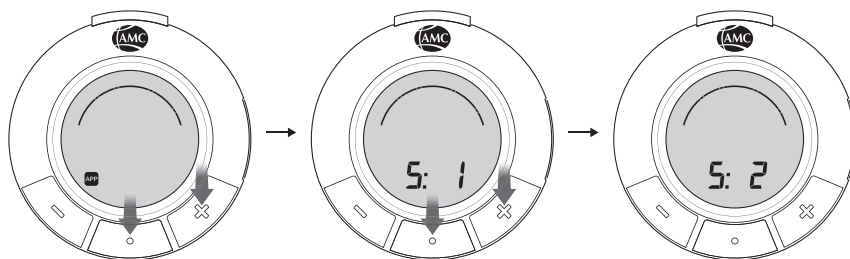

2.5.2 Modus voor mensen met een visuele handicap

De Audiotherm beschikt over een modus voor mensen met een visuele handicap (S: 0). Deze kan worden geactiveerd met de Audiotherm-app. In deze modus wordt bij het selecteren van de kookprogramma's voor elk kookprogramma een andere geluidsequentie afgespeeld. Bovendien is het signaal voor „Stand verhogen” (**+**) en „Stand verlagen” (**-**) verschillend. Alle andere geluidsignalen stemmen overeen met de modus „Pieptoon” (S: 2).

2.5.3 Weergave software en hardware uitvoering

➔ Druk tegelijkertijd op de —-toets en de middelste toets en houd deze ingedrukt.

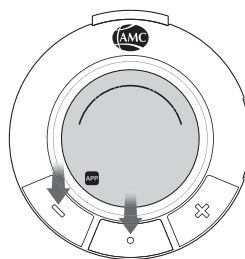

- Na een korte weergave van alle display-symbolen verschijnt het nummer van de software (bijv. 012) en daarna dat van de hardware (bijv. H01).

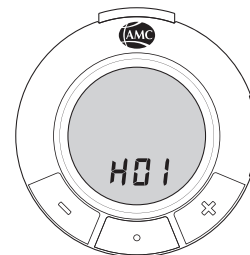
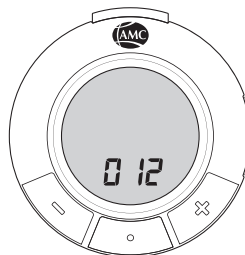

3. Wat te doen als ...

... er een kookprogramma wordt gekozen dat niet beschikbaar is op de gebruikte Visiotherm?

Bij het opzetten van de Audiotherm weerklinkt er een foutsignaal en het voordien gekozen kookprogramma verdwijnt van het display.

➔ Controleer in welk programma er moet worden gekookt.

... de op een programma ingestelde Audiotherm het contact verliest met de Visiotherm?

Er weerklinkt een foutsignaal.

➔ Laat de Audiotherm weer correct in de Visiotherm vergrendelen.

... de volgende foutmeldingen verschijnen?

E: 01

Fout in de Audiotherm-hardware.

➔ Neem contact op met de klantenservice.

E: 02

➔ Controleer of alle componenten correct zijn aangebracht en start het kookproces opnieuw.

E: 03

➔ Schakel de Audiotherm uit. Verwijder eventuele magnetische storingsbronnen uit de omgeving.

➔ Schakel de Audiotherm in en start het kookproces opnieuw.

➔ Als de fout meermaals ontstaat, neem dan contact op met de klantenservice.

E: 04

Fout in de Navigenio-hardware.

➔ Neem contact op met de klantenservice.

4. Onderhoud en reiniging

- Veeg de Audiotherm uitsluitend schoon met een vochtige doek en een beetje afwasmiddel.
- Onderhoud en reinig de Audiotherm regelmatig om de werking en veiligheid te verzekeren.
- Als de Audiotherm per ongeluk in het water valt:
 - ➔ schakel de Audiotherm onmiddellijk uit. Open het batterijvak, verwijder de batterijen en neem zichtbaar water op met een doek. Laat de geopende Audiotherm en het batterijvak ten minste 2 dagen drogen.



5. Audiotherm en app

De Audiotherm kan via een app worden bediend.

6. Afvalverwerking



De verpakking, de Audiotherm en de Visiotherm horen niet thuis bij het huishoudelijk afval. De materialen kunnen worden gerecycled. Voer ze daarom op een milieuvriendelijke wijze en conform de plaatselijke voorschriften af bij erkende inzamelpunten.



7. Technische gegevens

- 1,5 V-batterijen van het type AAA/LR03/Micro (bijv. alkaline)
- Oplaadbare 1,2 V-batterijen van hetzelfde type (bijv. NiMH)



8. Conformiteitsverklaring

De Audiotherm voldoet aan de CE-eisen volgens de Europese richtlijn betreffende radioapparatuur 2014/53/EU. Een volledige conformiteitsverklaring kunt u aanvragen via het adres dat onderaan in de paragraaf „AMC-klantenservice” is vermeld.

9. AMC-klantenservice

Als u vragen of suggesties hebt, neem dan contact op met de AMC-klantenservice.

Klantenservice

AMC Belgium

N.V. Alfa Metalcraft Corp. S.A.
Kortrijksesteenweg 205 - Bus 1
9830 Sint-Martens-Latem, Belgium
T: +32-(0)9-2509360

AMC Nederland

Alfa Metalcraft Corporation B.V.
Stadionlaan 167
5246 JT Rosmalen, Nederland
T: +31-(0)73-631 2530

AMC Visiotherm i Audiotherm

Upute za upotrebu

Sadržaj

1. Visiotherm	
1.1 Namjenska upotreba i sigurnost	82
1.1.1 Prikladni poklopci	82
1.1.2 Sigurnost	82
1.2 Pregled dijelova i prikaz	82
1.3 Montaža i prva upotreba	82
1.4 Čišćenje i održavanje	83
2. Audiotherm	
2.1 Namjenska upotreba i sigurnost	83
2.2 Prva upotreba Audiotherma i zamjena baterije	84
2.3 Struktura i zaslon	85
2.3.1 Pregled dijelova	85
2.3.2 Zaslon	85
2.4 Funkcije	86
2.4.1 Postavljanje na Visiotherm	86
2.4.2 Uključivanje	86
2.4.3 Namještanje vremena	87
2.4.4 Vremenski kontrolirano gratiniranje i pečenje	88
2.4.5 Namještanje kuhinjskog brojača vremena	89
2.4.6 Odabir programa kuhanja	89
2.4.7 Isključivanje signalnog tona	90
2.4.8 Uklanjanje Audiotherma s Visiotherma	90
2.4.9 Isključivanje Audiotherma	90
2.5 Dodatne funkcije	90
2.5.1 Promjena tona	90
2.5.2 Način rada za osobe s oštećenjem vida	90
2.5.3 Prikaz softvera i hardvera	91
3. Što učiniti kada ...	91
4. Čišćenje i održavanje	92
5. Audiotherm i aplikacija	92
6. Zbrinjavanje	92
7. Tehnički podatci	92
8. Izjava o sukladnosti	92
9. AMC služba za korisnike	92

Visiotherm i Audiotherm namijenjeni su isključivo za pravilnu upotrebu u domaćinstvu. Nепrimjerena upotreba može biti opasna.

Prije početka upotrebe Visiotherma i Audiotherma pažljivo pročitajte upute za upotrebu, a posebno napomene o namjenskoj upotrebi i sigurnosti. Sačuvajte upute za upotrebu i prosljedite ih sljedećem vlasniku.

Osim toga, pažljivo pročitajte i priručnik „Kuhanje s AMC-om” i pripadajuće upute za upotrebu ostalih AMC proizvoda.

Značenje simbola



Važne sigurnosne upute. Nepoštivanje uputa može uzrokovati ozljede ili štete.



Pogrešan način rada ili neprimjerena upotreba.



Ispravan način rada ili primjerena upotreba.



Korisne upute za primjenu.



Upute za zaštitu okoliša, ekologiju i ekonomičnost.



Opisi postupaka istaknuti su strelicom.

Verzija uputa za upotrebu za Visiotherm i Audiotherm: 07/2020.

1. Visiotherm

Visiotherm na AMC poklopcima mjeri temperaturu u posudi i tavi te je prikazuje na zaslonu. Visiotherm tako vizualno prikazuje da li je posudi ili tavi postignuta željena temperatura.

1.1 Namjenska upotreba i sigurnost

1.1.1 Prikladni poklopci

Visiotherm je prikladan za sve poklopce AMC posuda i tava.



1.1.2 Sigurnost

- Obratite pozornost na opasnosti uslijed vrućine; vruće poklopce primajte samo za Visiotherm.
- Visiotherm je opremljen magnetom za prijenos temperature. Srčani stimulator može se uključiti u probnom načinu rada i uzrokovati tegobe ako se nalazi na udaljenosti manjoj od 2 cm od okna Visiotherma.
- Funkcija kreditnih kartica, EC-kartica, nosača podataka, slušnih pomagala ili mehaničkih satova može se ograničiti ako se nalaze na udaljenosti manjoj od 2 cm od okna Visiotherma.
- Visiotherm ne upotrebljavati u pećnici ili mikrovalnoj pećnici.

1.2 Pregled dijelova i prikaz

- | | |
|---|------------------------------|
| 1 | Indikator |
| 2 | Okno za pečenje |
| 3 | Točka okretanja |
| 4 | Okno za povrće |
| 5 | Temperaturni raspon „Povrće” |
| 6 | Okno za zaustavljanje |

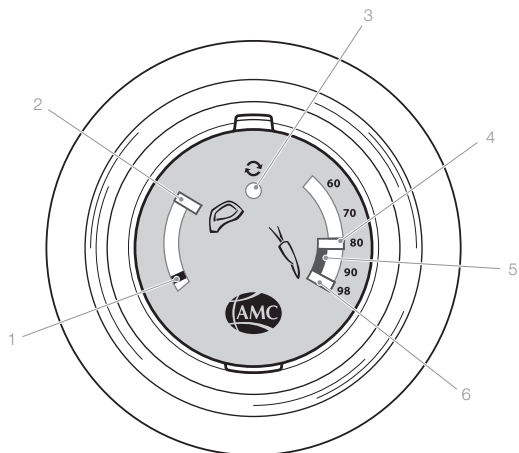

Obratiti pozornost na opise i savjete u brošuri „Kuhanje s AMC-om”.

1.3 Montaža i prva upotreba

- ➔ Prije prve upotrebe Visiotherm prebrisati vlažnom krpom.
- ➔ Visiotherm okretanjem učvrstiti na poklopac.

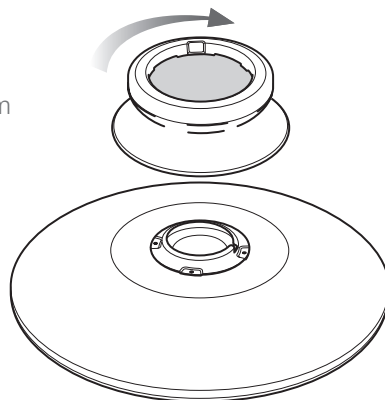

1.4 Čišćenje i održavanje

- ➔ Odvrnuti Visiotherm s poklopca; oprati oba proizvoda u perilici za posuđe ili ručno.
- ➔ Za perilicu za posuđe upotrebljavati uobičajena sredstva za pranje u perilici.
- ➔ Tijekom ručnog čišćenja upotrebljavati krpu za pranje ili mekanu spužvu i neutralno sredstvo za pranje.



2. Audiotherm

2.1 Namjenska upotreba i sigurnost

Audiotherm u kombinaciji s Visiothermom nadzire postupak kuhanja. Audiotherm prikazuje temperaturu u posudi koju je izmjerio Visiotherm i služi kao zvučni nadzor temperature i vremena kuhanja te kao sustav upravljanja pri kontroliranom kuhanju na ploči Navigenio.

Prikladni poklopci

- Poklopac s Visiothermom
- Poklopac za kuhanje na pari EasyQuick s Visiothermom E
- Poklopac za brzo kuhanje „Secuquick softline” s Visiothermom S



Izbjegavati oštećenja i neprimjerenu upotrebu.

- Audiotherm ne upotrebljavati u pećnici ili mikrovalnoj pećnici niti ga izlagati temperaturama većim od 70 °C.
- Nikada ne uranjati Audiotherm u vodu niti ga prati u perilici za posuđe.
- Audiotherm služi nadzoru ili upravljanju postupkom kuhanja. Audiotherm se smije upotrebljavati samo u tu svrhu. Neprimjerena upotreba može biti opasna.
- Audiotherm sadrži baterije. Baterije ne smiju dospjeti u dječje ruke jer ih dijete može progutati.
- Upotrebljavati samo baterije preporučene i istovjetne vrste (u skladu s poglavljem 5).
- Ne pokušavati puniti baterije koje nisu punjive.

Obratiti pozornost i na upute za upotrebu proizvoda EasyQuick, Secuquick softline i Navigenio te opise i savjete u brošuri „Kuhanje s AMC-om”.



Nadzor

- Postupak kuhanja mora se nadzirati. Za zvučni nadzor postupka kuhanja upotrebljavati Audiotherm samo kad ste na dovoljnoj udaljenosti da ga možete čuti.
- Pri nekontroliranom kuhanju bez nadzora može doći do pregrijavanja. Na taj se način može dogoditi da jelo ne uspije, a posuda ošteti ili uništi. Opasnost od nezgoda i požara.
- Djeca mlađa od 8 godina ili osobe ograničenih tjelesnih, osjetilnih ili duševnih sposobnosti, odnosno s nedovoljno iskustva ili znanja, mogu upotrebljavati uređaj. Međutim, moraju biti pod nadzorom ili upućeni u siguran rad uređajem te razumjeti moguće opasnosti. To se odnosi i na zvučni nadzor kod osoba s oštećenjem vida (vidi poglavlje 2.5.2).

2.2 Prva upotreba Audiotherma i zamjena baterija

Prva upotreba:

S Audiothermom dobivate dvije baterije (tip u skladu s poglavljem 5).

Prije prve upotrebe umetnuti baterije.

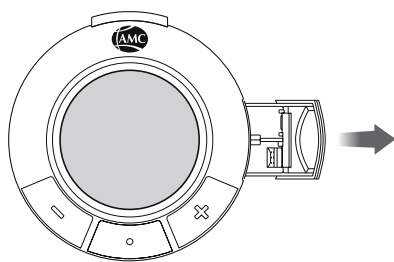

- ➔ Otvoriti pretinac za baterije i izvući držač za baterije.

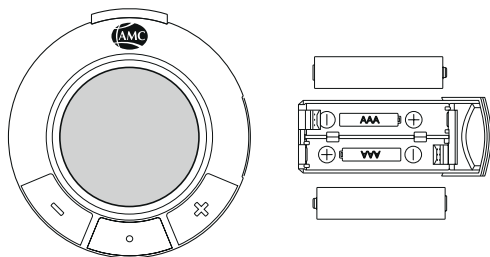

- ➔ Pravilno umetnuti baterije u skladu s prikazom na slici.

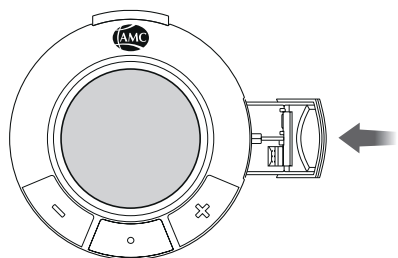

- ➔ Umetnuti držač za baterije u Audiotherm i zatvoriti tako da se začuje „klik“.

Zamjena baterija:

Ako je na zaslonu vidljiv prikaz baterije, vrijeme je za zamjenu baterija.



Ispražnjene baterije zbrinuti na ekološki prihvatljiv način, u skladu s lokalnim propisima!

2.3 Struktura i zaslon

2.3.1 Pregled dijelova

- 1 Tipka za otključavanje
- 2 - tipka
- 3 Srednja tipka
- 4 + tipka

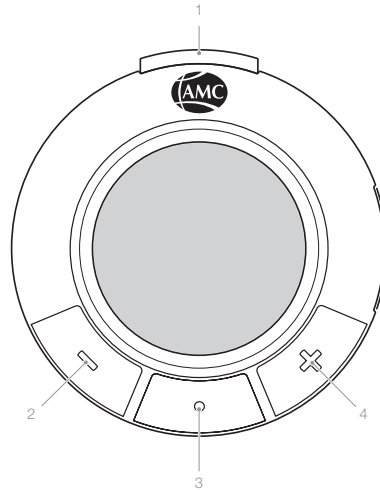

2.3.2. Zaslona

- 1 Simbol Soft
- 2 Simbol za pečenje
- 3 Simbol za povrće
- 4 Orijentacijska linija
- 5 Simbol „Točka okretanja”
- 6 Točka okretanja
- 7 Simbol za paru
- 8 Simbol 60 °C
- 9 Prikaz minusa

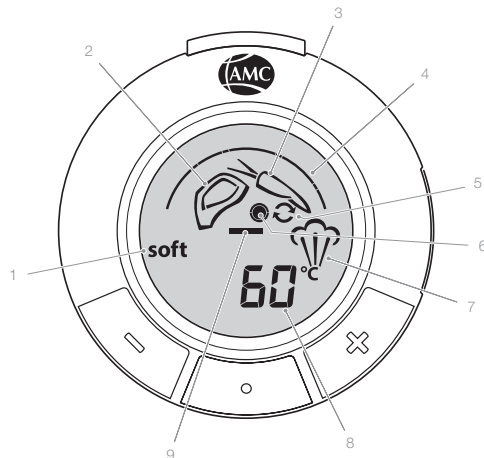

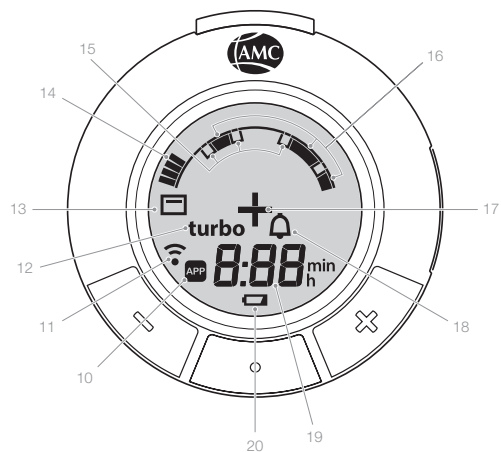

- 10 Veza „Aplikacija”
- 11 Veza „Navigenio”
- 12 Simbol Turbo
- 13 Simbol Pečenje
- 14 Temperaturna skala
- 15 Točke radnji
- 16 Temperaturni rasponi
- 17 Prikaz plusa
- 18 Simbol kuhinjskog brojača vremena
- 19 Prikaz vremena
- 20 Prikaz baterije



2.4 Svojstva

AMC-ov sustav za kuhanje obuhvaća razne metode kuhanja, za koje Audiotherm može biti upotrebljavan na dva načina.

Manualno kuhanje uz Visiotherm i Audiotherm:

- Audiotherm prikazuje aktualnu temperaturu i signalnim tonovima  ukazuje na to kada je potrebno nešto učiniti. Na zaslону prikazuje što je potrebno učiniti.
- Audiotherm signalnim tonom  ukazuje na to da je vrijeme kuhanja isteklo.
- Rukovanje površinom za kuhanje provodi korisnik.

Samokontrolirano kuhanje:

Audiotherm omogućuje samokontrolirano kuhanje na mobilnoj ploči za kuhanje „Navigenio“.

- Audiotherm putem radio veze s pločom Navigenio samostalno nadzire cjelokupan proces kuhanja.
- Nakon uključivanja ploče Navigenio na „A“, Audiotherm preuzima rukovanje pločom Navigenio.
- Audiotherm signalnim tonom  ukazuje na to da je uneseno vrijeme kuhanja isteklo.



Sve funkcije kuhanja (iznimka: planirano kuhanje i program od 60 °C) mogu se provesti kako manualno tako i samokontrolirano.

Obavezno slijediti opise i savjete iz priručnika „Kuhanje s AMC-om“.

2.4.1 Postavljanje na Visiotherm

- ➔ Postaviti Audiotherm s pritisnim gumbom usmjerenim prema gore na Visiotherm i uklapati ga dok se ne začuje „klik“.

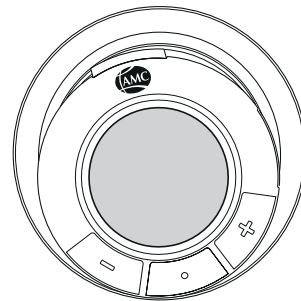

2.4.2 Uključivanje

- ➔ Pritisnuti bilo koju tipku.

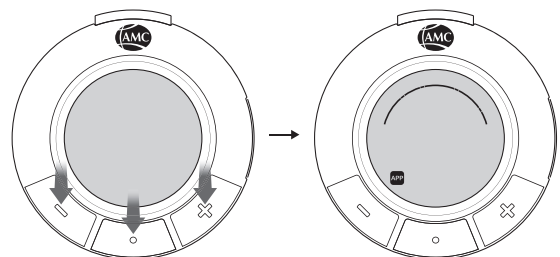

2.4.3 Namještanje vremena



Vrijeme se može namjestiti prije ili nakon što se Audiotherm postavi na Visiotherm, odnosno prije ili nakon odabira željenog programa kuhanja. Vrijeme koje se prikaže pri prvom pritiskanju tipki prethodno je namještena vrijednost kojom se olakšava unos.

Vrijeme kuhanja

Kako bi se vrijeme kuhanja moglo nadzirati, ono se može unijeti u Audiotherm. Namješteno vrijeme kuhanja početak će teći nakon dosezanja odgovarajuće temperature kuhanja.

➔ Uključiti.

➔ Pritisnuti tipku **+** za odabir kratkog vremena (0:10) ili povećanje željenog vremena kuhanja (držati pritisnutu tipku za brzu promjenu),

ili

➔ Pritisnuti tipku **-** za odabir dugačkog vremena (1:00) ili smanjenje željenog vremena kuhanja (držati pritisnutu tipku za brzu promjenu).

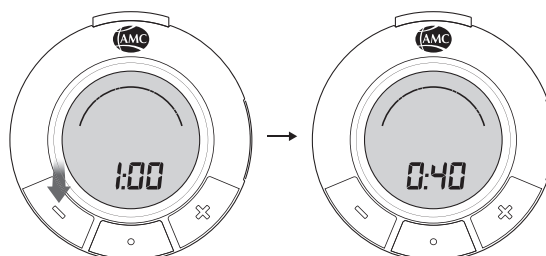
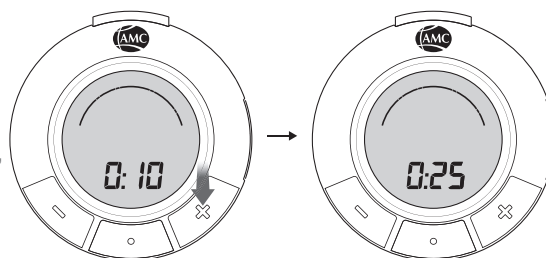

Vremenska postavka „P”

➔ Nakon uključivanja pritisnuti tipku **-**, a zatim tipku **+**.

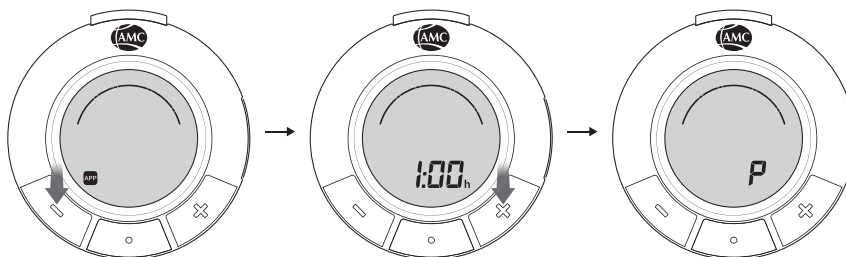

Ako se ne zada vrijeme kuhanja, Audiotherm će kontrolirati temperaturu za željeni postupak kuhanja bez vremenskog ograničenja. Vrijeme kuhanja može se namjestiti i nakon početka postupka kuhanja te mijenjati po želji.

Slijedite opise i savjete iz priručnika „Kuhanje s AMC-om”.

Planirano kuhanje „+“

Audiotherm u kontroliranom načinu rada s pločom Navigenio na stupnju „A“ može se namjestiti tako da postupak kuhanja započne u kasnijem trenutku (odgađanje početka).

➔ Uključiti i unijeti vrijeme kuhanja.

- Čim se na zaslonu prikaže „+“.

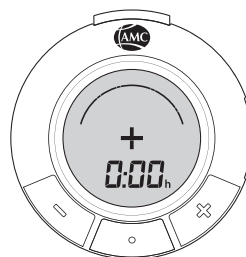

➔ Pritisnuti tipku + za odabir kratkog vremena odgađanja početka (1:00) ili povećanje željenog vremena (držati pritisnutom za brzu promjenu),

ili

➔ Pritisnuti tipku - za odabir kratkog vremena odgađanja početka (8:00) ili smanjenje željenog vremena (držati pritisnutom za brzu promjenu).

- Na zaslonu se naizmjenično prikazuje vrijeme kuhanja i vrijeme odgađanja početka putem prikaza „+“.

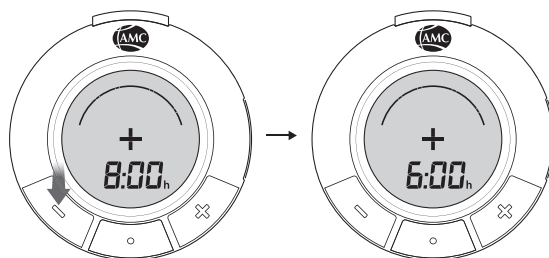
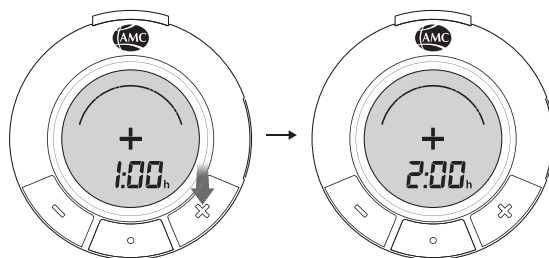

Namješteno vrijeme odgađanja početka može se mijenjati prema želji.

Promjena vremena odgađanja početka, odnosno vremena kuhanja uvijek se može provesti kada se ono prikazuje na zaslonu.

Slijediti opise i savjete iz priručnika „Kuhanje s AMC-om“.

2.4.4 Vremenski kontrolirano gratiniranje i pečenje

Da bi se vrijeme moglo nadzirati, mora se unijeti u Audiotherm. Vrijeme se može unijeti dokle god svjetlo na ploči Navigenio uključenoj na željenom stupnju naizmjenično treperi plavom/crvenom bojom.

➔ Pritiskati srednju tipku do prikaza simbola Pečenje.

➔ Pritisnuti tipku + za povećanje željenog vremena (držati pritisnutom za brzu promjenu).

➔ Pritisnuti tipku - za smanjenje željenog vremena (držati pritisnutom za brzu promjenu).

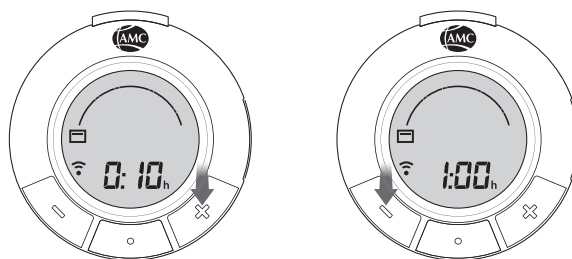

2.4.5 Namještanje kuhinjskog brojača vremena

- ➔ Uključiti i pritisnuti srednju tipku.

Primjer: Audiotherm nije postavljen.

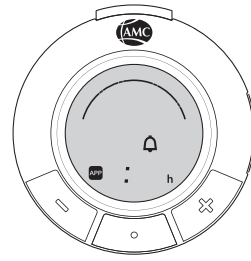

- ➔ Pritisnuti tipku **+** za povećanje željenog vremena (držati pritisnutom za brzu promjenu)

ili

- ➔ Pritisnuti tipku **-** za smanjenje željenog vremena (držati pritisnutom za brzu promjenu).

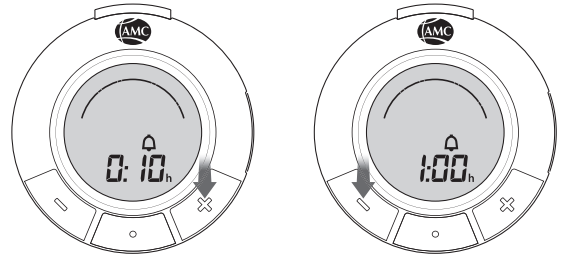

Slijediti opise i savjete iz priručnika „Kuhanje s AMC-om”.

2.4.6 Odabir programa kuhanja

- ➔ Programi kuhanja mogu se odabrati pritiskom srednje tipke.

Primjer: Audiotherm je postavljen na Visiotherm.

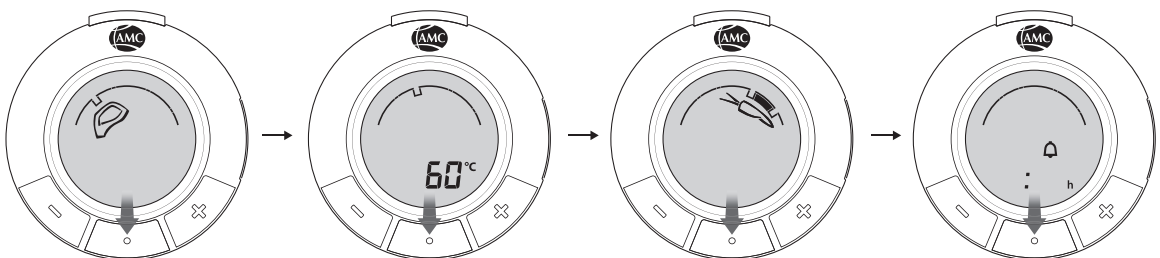

Programi se mogu birati prije ili nakon što se Audiotherm postavi na Visiotherm.

2.4.7 Isključivanje signalnog tona

- ➔ Pritisnuti bilo koju tipku.
- U protivnom će se signalni ton isključiti nakon 1 minute.

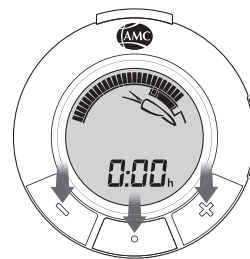

2.4.8 Uklanjanje Audiotherma s Visiotherma

- ➔ Pritisnuti tipku za otključavanje i ukloniti Audiotherm.

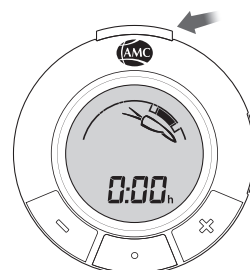

2.4.9 Isključivanje Audiotherma

- ➔ Držati srednju tipku oko 2 sekunde.

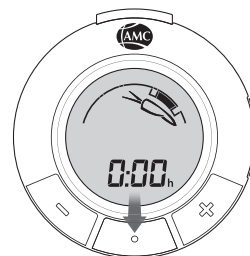

Audiotherm je nakon upotrebe uvijek potrebno ukloniti s Visiotherma. Nikada ga se ne smije uranjati u vodu niti prati u perilici za posuđe.

2.5 Dodatna svojstva

2.5.1 Promjena tona

- ➔ Uključivanje.
- ➔ Istovremeno pritisnuti tipku **+** i srednju tipku.

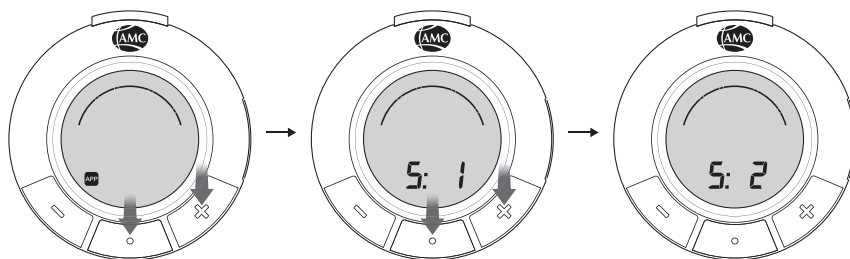

- Moguće je birati između melodije (S: 1) ili zvučnog signala (S: 2).

2.5.2 Način rada za osobe s oštećenjem vida

Audiotherm raspolaže načinom rada za osobe s oštećenjem vida (S: 0). On se može aktivirati putem aplikacije na Audiothermu. U ovom se načinu rada pri odabiru programa kuhanja za svaki program reproducira drukčiji slijed tonova. Također, javlja se drukčiji signal za „Povećanje stupnja” (**+**) i „Smanjenje stupnja” (**-**). Svi drugi signali odgovaraju načinu rada „Zvučni signal” (S: 2).

2.5.3 Prikaz softvera i hardvera

➔ Istovremeno pritisnuti i držati tipku **—** i srednju tipku.

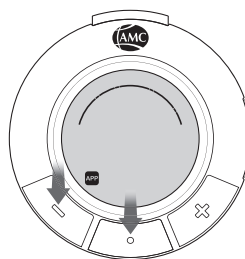

▪ Nakon kratkog prikaza svih simbola zaslona prikazat će se broj softvera (npr. 012), a zatim i hardvera (npr. H01).

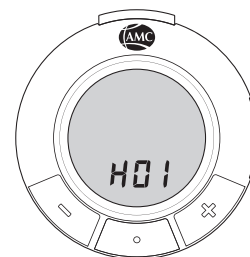

3. Što učiniti kada ...

... se odabere program kuhanja koji nije dostupan na Visiothermu koji se koristi?

Pri postavljanju Audiotherma reproducirat će se ton pogreške, a prethodno odabrani program kuhanja nestat će sa zaslona.

➔ Provjeriti u kojem je programu potrebno kuhati.

... Audiotherm postavljen na određeni program izgubi kontakt s Visiothermom?

Reproducirat će se ton pogreške.

➔ Audiotherm ponovno pravilno uklopiti u Visiotherm.

... se pojave sljedeće obavijesti o pogreškama?

E: 01

Pogreška u hardveru Audiotherma.

➔ Potrebno je obratiti se službi za korisnike.

E: 02

➔ Provjeriti jesu li sve komponente pravilno postavljene i ponovno pokrenuti postupak kuhanja.

E: 03

- ➔ Isključiti Audiotherm. Ukloniti sve izvore magnetskog ometanja iz okoline.
- ➔ Uključiti Audiotherm i ponovno pokrenuti postupak kuhanja.
- ➔ Ako se pogreška ponovno pojavi, potrebno je obratiti se službi za korisnike.

E: 04

Pogreška u hardveru ploče Navigenio.

➔ Potrebno je obratiti se službi za korisnike.

4. Čišćenje i održavanje

- Prebrisati Audiotherm blago navlaženom krpom.
- Redovito čistiti i održavati Audiotherm kako bi se zajamčili funkcionalnost i sigurnost.
- Ako Audiotherm padne u vodu:
 - ➔ Odmah isključiti Audiotherm. Otvoriti pretinac za baterije, ukloniti baterije, svu vidljivu vodu osušiti krpom. Pustiti otvoreni Audiotherm i pretinac za baterije da se suše najmanje 2 dana.



5. Audiotherm i aplikacija

Audiothermom je moguće rukovati putem aplikacije.

6. Zbrinjavanje



Ambalaža, Audiotherm ni Visiotherm ne smiju se zbrinjavati u kućnom otpadu. Materijal se može reciklirati. Potrebno ih je zbrinuti na ekološki prihvatljiv način, u skladu s lokalnim propisima, na prikladnim odlagalištima.



7. Tehnički podatci

- 1,5 V baterije veličine AAA/LR03/Micro (npr. Alkaline)
- Punjive 1,2 V baterije jednake veličine (npr. NiMH)



8. Izjava o sukladnosti

Audiotherm ispunjava zahtjeve CE u skladu s europskom Direktivom o radijskoj opremi 2014/53/EU. Cjelokupna Izjava o sukladnosti dostupna je putem adrese koja je navedena u odjeljku „AMC služba za korisnike” u nastavku.

9. AMC služba za korisnike

Ako imate pitanja ili prijedloge, stupite u kontakt s AMC službom za korisnike.

Servis za klijente

AMC Hrvatska
 AMC Alfa Metalcraft d.o.o.
 Kreše Golika 3
 10090 Zagreb, Hrvatska

+ 385 1 6195 589

AMC Visiotherm in Audiotherm

Navodila za uporabo

Kazalo

1. Visiotherm	
1.1 Ustrezna uporaba in varnost	95
1.1.1 Ustrezne pokrovke	95
1.1.2 Varnost	95
1.2 Elementi prikazovalnika	95
1.3 Nameščanje in začetek uporabe	96
1.4 Nega in čiščenje	96
2. Audiotherm	
2.1 Ustrezna uporaba in varnost	96
2.2 Prva uporaba Audiotherma in vstavljanje baterij	97
2.3 Elementi prikazovalnika	98
2.3.1 Elementi	98
2.3.2 Prikazovalnik	98
2.4 Funkcije	99
2.4.1 Namestitev na Visiotherm	99
2.4.2 Vkllop	99
2.4.3 Nastavitev časa	100
2.4.4 Časovno nadzorovano gratiniranje in peka	101
2.4.5 Nastavitev opozorilnika	102
2.4.6 Izbira programa kuhanja	102
2.4.7 Izklop opozorilnega zvoka	103
2.4.8 Odstranitev Audiotherma z Visiotherma	103
2.4.9 Izklop Audiotherma	103
2.5 Dodatne funkcije	103
2.5.1 Sprememba zvoka	103
2.5.2 Način za slabovidne osebe	103
2.5.3 Prikaz programske in strojne opreme	104
3. Kaj storiti, če...	104
4. Nega in čiščenje	105
5. Audiotherm in uporaba	105
6. Odstranitev	105
7. Tehnični podatki	105
8. Izjava o skladnosti	105
9. AMC služba za pomoč uporabnikom	105

Visiothermom in Audiotherm sta predvidena izključno za uporabo v domačem gospodinjstvu. Pri nepravilni uporabi lahko pride do nevarnosti.

Pozorno preberite navodila za uporabo, zlasti napotke za ustrezno uporabo in varnost, preden začnete uporabljati Audiotherm in Visiotherm. Navodila za uporabo shranite in jih izročite naslednjemu lastniku.

Poleg tega pozorno preberite tudi brošuro „Kuhanje z AMC“ in pripadajoča navodila za uporabo drugih AMC izdelkov, ki jih uporabljate.

Pomen simbolov



Pomembna navodila za varnost. Pomembna navodila za varnost. Nepravilna uporaba lahko povzroči poškodbe ali materialno škodo.



Neustrezna ali nestrokovna uporaba.



Ustrezna ali strokovna uporaba.



Koristni napotki za uporabnika.



Napotki za varovanje okolja ter za bolj ekološko in ekonomično uporabo.



Koraki postopka so označeni s puščico.

Različica navodil za uporabo Visiotherma in Audiotherma: 7/2020

1. Visiotherm

Visiotherm na AMC pokrovki meri temperaturo v loncu in ponvi ter jo prikaže na prikazovalniku. Visiotherm optično prikaže, ali je v loncu oz. ponvi želena temperatura.

1.1 Ustrezna uporaba in varnost

1.1.1 Ustrezne pokrovke

Visiotherm je primeren za vse AMC pokrovke loncev in ponev.



1.1.2 Varnost

- Upoštevajte nevarnosti zaradi segrevanja, vroče pokrove primite samo za Visiotherm.
- Visiotherm je opremljen z magnetom, ki pomaga pri merjenju temperature. Srčni spodbujevalnik se lahko preklopi v testni način in povzroči nelagodno počutje, če je od prikazovalnika Visiotherma oddaljen manj kot 2 cm.
- Kreditne kartice, EC kartice, nosilci podatkov, slušni aparati ali mehanske ure lahko nepravilno delujejo, če so od prikazovalnika Visiotherma oddaljene manj kot 2 cm.
- Visiotherma ne uporabljajte v pečici ali mikrovalovni pečici.

1.2 Elementi prikazovalnika

- 1 Kazalec
- 2 Okence za pečenje
- 3 Točka obračanja
- 4 Okence za kuhanje
- 5 Območje idealne temperature kuhanja
- 6 Okence za zaustavitev

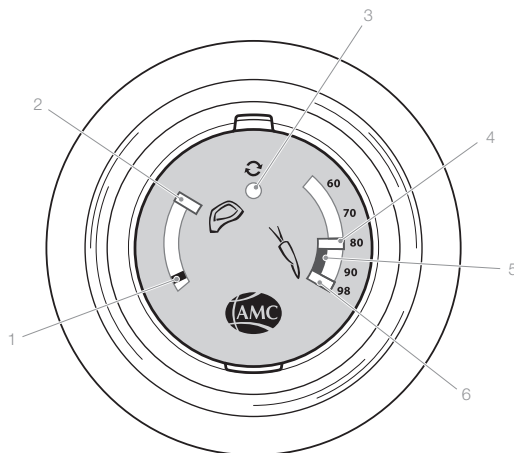

Upoštevajte opise in nasvete v brošuri „Kuhanje z AMC“.

1.3 Nameščanje in prva uporaba

- ➔ Visiotherm pred prvo uporabo obrišite z vlažno krpo.
- ➔ Visiotherm vstavite privijte na pokrovko.

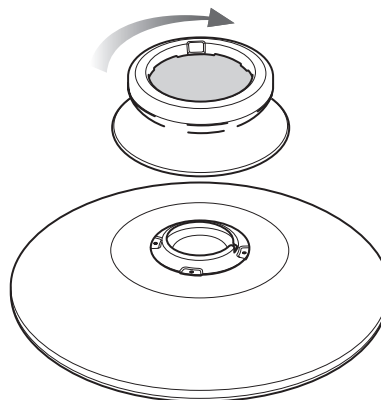

1.4 Nega in čiščenje

- ➔ Visiotherm odvijte s pokrovke in oba pomijte v pomivalnem stroju ali očistite ročno.
- ➔ Uporabljajte običajna stroju prijazna gospodinjska čistila za pomivalni stroj.
- ➔ Pri ročnem čiščenju uporabljajte krpo za posodo ali mehko gobico ter nevtralni detergent.



2. Audiotherm

2.1 Ustrezna uporaba in varnost

Audiotherm skupaj z Visiothermom nadzoruje kuhanje. Audiotherm prikaže temperaturo, ki jo Visiotherm izmeri v posodi in služi kot zvočni nadzor temperature in časa kuhanja ter kot regulator pri nadzorovanem kuhanju z Navigeniom.

Ustrezne pokrovke

- Pokrovka z Visiothermom
- Pokrovka za kuhanje v sopari EasyQuick z Visiothermom E
- Pokrovka za hitro kuhanje „Secuquick softline“ z Visiothermom S



Preprečite poškodbe in nestrokovno uporabo.

- Audiotherma ne uporabljajte v pečici ali mikrovalovni pečici ter ga ne izpostavljajte temperaturam nad 70 °C.
- Audiotherma nikoli ne potaplajte v vodo in ga ne dajajte v pomivalni stroj.
- Audiotherm služi spremljanju in nadzoru postopka kuhanja. Audiotherm je dovoljeno uporabljati le v ta namen. Pri nepravilni uporabi lahko pride do nevarnosti.
- Audiotherm vsebuje bateriji. Bateriji ne smeta priti v otroške roke, ker jih je mogoče pogoltniti.
- Uporabljajte samo priporočene in ustrzne vrste baterij (uporabljajte v skladu z opisom v poglavju 5).
- Ne poskušajte polniti baterij, ki niso primerne za ponovno polnjenje.

Upoštevajte tudi navodila za uporabo EasyQuick, Secuquick softline in Navigenia ter napotke in nasvete v brošuri „Kuhanje z AMC“.



Nadzor

- Kuhanje je treba nadzorovati. Za zvočni nadzor postopka kuhanja Audiotherm uporabljajte samo v slušnem dosegu.
- Nenadzorovano, nekontrolirano kuhanje lahko privede do pregrevanja. Jedi se lahko prismodijo in posoda se lahko poškoduje ali uniči. Obstaja nevarnost nesreče in požara.
- Izdelek lahko uporabljajo otroci stari vsaj 8. leta in osebe z omejenimi fizičnimi, zaznavnimi ali duševnimi sposobnostmi oz. pomanjkanjem izkušenj ali znanja. Morajo pa biti nadzorovane ali poučene glede varne uporabe naprave in razumeti nevarnosti, ki lahko zaradi tega nastanejo. To se nanaša tudi na zvočni nadzor za slabovidne osebe (glejte poglavje 2.5.2).

2.2 Prva uporaba Audiotherma in vstavljanje baterij

Prva uporaba:

Audiothermu sta priloženi dve bateriji (vrsta opisana v poglavju 5).

Vstavljanje baterij pred prvo uporabo.

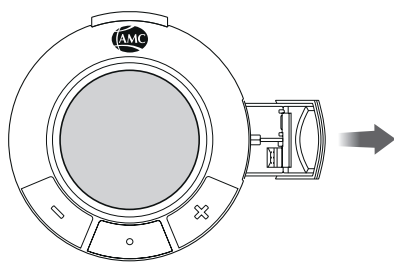

➔ Odprite predalček za baterije in izvlecite nosilec baterij.

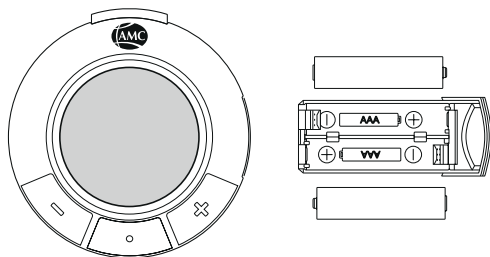

➔ Pravilno vstavite bateriji, kot je prikazano na sliki.

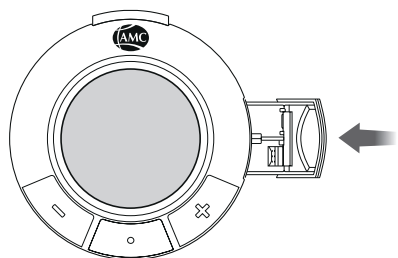

➔ Vstavite nosilec baterij v Audiotherm in zaprite s „klikom“.

Menjava baterij:

Če se na prikazovalniku prikaže simbol za baterijo, baterije čim prej zamenjajte.



Iztrošene baterije odstranite ustrezno lokalnim predpisom!

2.3 Elementi prikazovalnika

2.3.1 Elementi

- 1 Gumb za odklepanje
- 2 —-gumb
- 3 Srednji gumb
- 4 +-gumb

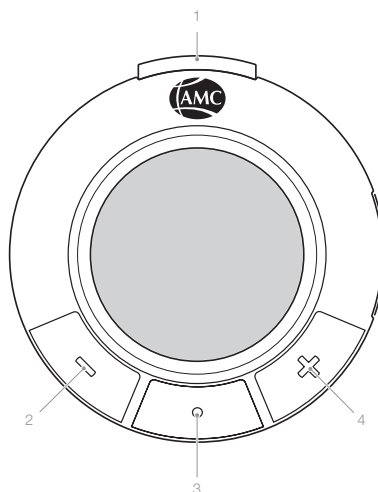

2.3.2. Prikazovalnik

- 1 Simbol Soft
- 2 Simbol za pečenje
- 3 Simbol za kuhanje
- 4 Orientacijska črta
- 5 Simbol „Točka obračanja“
- 6 Točka obračanja
- 7 Simbol za kuhanje v sopari
- 8 Simbol 60 °C
- 9 Simbol minus

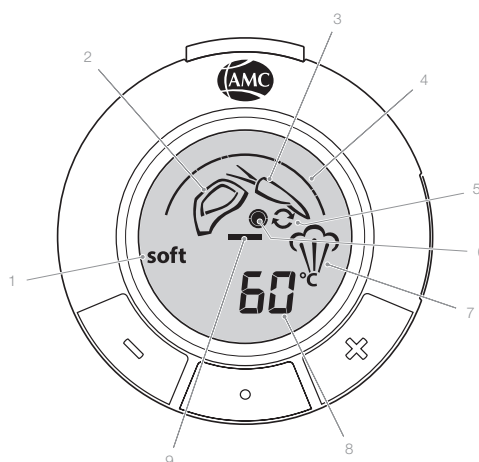

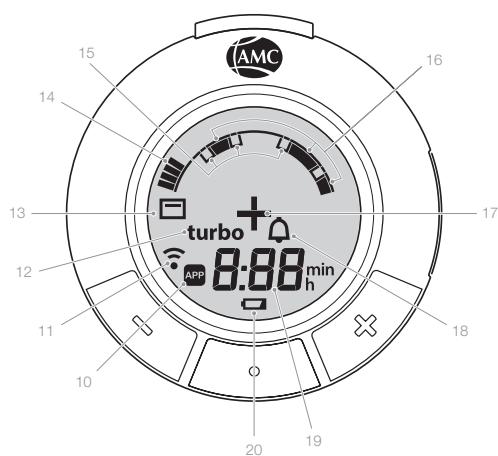

- 10 Povezava z Aplikacijo
- 11 Povezava z Navigeniom
- 12 Simbol Turbo
- 13 Simbol za pečenje
- 14 Temperaturna lestvica
- 15 Točke za akcijo
- 16 Temperaturna območja
- 17 Simbol plus
- 18 Simbol za opozorilnik
- 19 Prikaz časa
- 20 Simbol baterije



2.4 Funkcije

AMC sistem kuhanja sestavljajo različne metode kuhanja. Audiotherm je mogoče pri tem uporabiti na dva različna načina.

Ročno kuhanje z Visiothermom in Audiothermom:

- Audiotherm prikazuje trenutno temperaturo in z opozorilnimi zvoki  opozarja, ko je treba kaj storiti. Na prikazovalniku prikaže, kaj je treba storiti.
- Audiotherm z opozorilnim zvokom  opozarja, da je čas kuhanja potekel.
- Uporabnik upravlja kahalno ploščo ročno.

Nadzorovano kuhanje:

Pri kuhanju na prenosnem kuhališču Navigenio Audiotherm omogoča nadzorovano kuhanje.

- Audiotherm prek radijske povezave z Navigeniom samodejno nadzoruje celoten potek kuhanja.
- Po vklopu Navigenia na «A» upravljanje prevzame Navigenio z Audiothermom.
- Audiotherm z opozorilnim zvokom  opozarja, da je vneseni čas kuhanja potekel.



Vse funkcije kuhanja (izjema: kuhanje z zamikom in program 60 °C) se lahko izvedejo ročno ali nadzorovano.

Upoštevajte opise in nasvete v poglavju „AMC metode kuhanja“.

2.4.1 Namestitev na Visiotherm

- ➔ Audiotherm z gumbom za odklepanje obrnjenim navzgor namestite na Visiotherm in pustite, da se zaskoči s „klikom“.

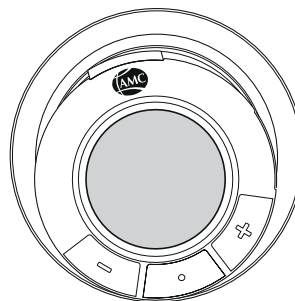

2.4.2 Vklop

- ➔ Pritisnite poljubni gumb.

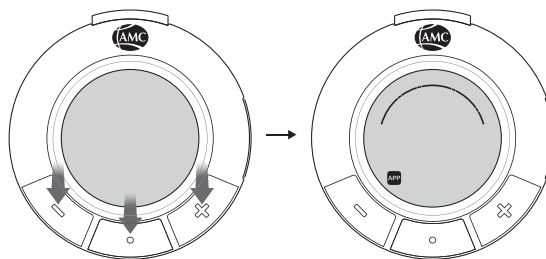

2.4.3 Nastavitev časa



Čase je mogoče nastaviti pred ali po namestitvi Audiotherma na Visiotherm oz. pred ali po izbiri ustreznega programa kuhanja. Vsi časi, ki se prikažejo ob prvem pritisku tipk, so prednastavljene vrednosti, da se olajša vnos.

Čas kuhanja

Za nadzor časa kuhanja lahko ta čas vnesete v Audiotherm. Nastavljeni čas kuhanja začne teči, ko je dosežena ustrezna temperatura kuhanja.

➔ Vklopite.

➔ Pritisnite gumb **+**, da izberete kratek čas (0:10) ali podaljšate želeni čas kuhanja (pridržite za hitri način)

ali

➔ Pritisnite gumb **-**, da izberete dolgi čas (1:00) ali skrajšate želeni čas kuhanja (pridržite za hitri način).

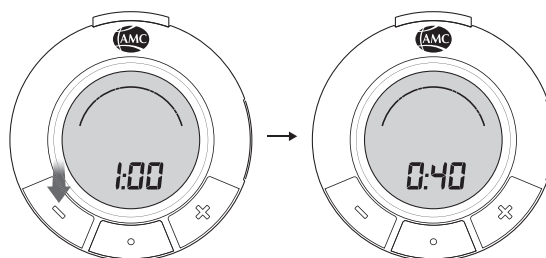
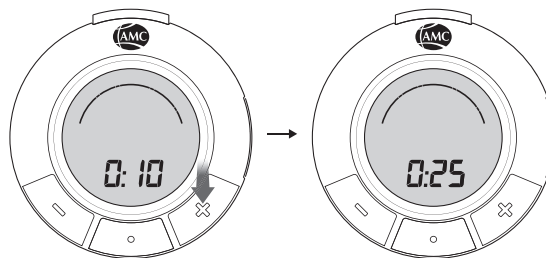

Nastavitev časa „P“

➔ Po vklopu pritisnite gumb **-** in nato gumb **+**.

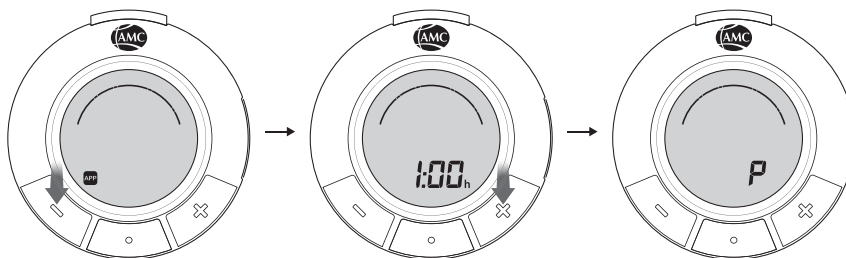

Audiotherm brez nastavitve časa nadzoruje temperaturo za želeni postopek kuhanja brez časovne omejitve. Čas kuhanja je mogoče nastaviti tudi po začetku kuhanja in ga je mogoče spremeniti kadarkoli med delovanja.

Upoštevajte opise in nasvete v poglavju „AMC metode kuhanja“.

Načrtovano kuhanje „+“

Audiotherm je mogoče med nadzorovanim delovanjem z Navigeniom na stopnji „A“ nastaviti tako, da se postopek kuhanja začne pozneje (zamik začetka kuhanja).

- ➔ Vklonite in vnesite čas kuhanja.
- Takoj ko se na prikazovalniku prikaže „+“.

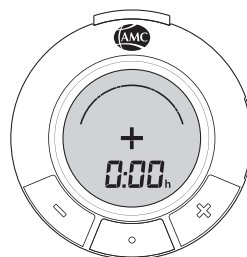

- ➔ Pritisnite tipko +, da izberete krajši zamik začetka kuhanja (1:00) ali podaljšate želeni čas zamika (pridržite za hitri način)

ali

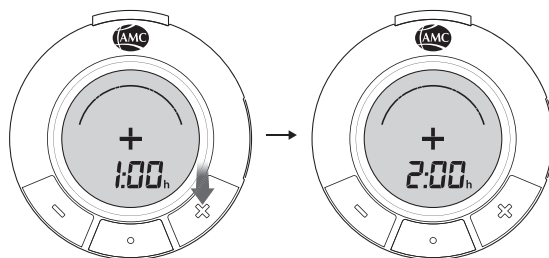

- ➔ Pritisnite tipko +, da izberete daljši zamik začetka kuhanja (8:00) ali skrajšate želeni zamik (pridržite za hitri način).

- Na prikazovalniku se izmenjaje prikazujeta čas kuhanja in odlog začetka kuhanja z „+“.

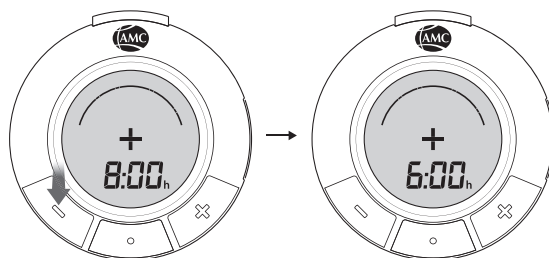

Odlog začetka kuhanja je mogoče spremeniti med celotnim časom delovanja.

Odlog začetka kuhanja oz. časa kuhanja je mogoče spremeniti vedno takrat, ko je ta prikazan na prikazovalniku.

Upoštevajte opise in nasvete v poglavju „AMC metode kuhanja“.

2.4.4 Časovno nadzorovano gratiniranje in pečenje

Za nadzor časa lahko tega vnesete v Audiotherm. Čas je mogoče vnesti, dokler na Navigeniu, ki je nastavljenem na želeni stopnji, izmenjaje utripa modro/rdeča lučka.

- ➔ Pritiskajte srednji gumb, dokler se ne prikaže simbol za pečenje.
- ➔ Pritisnite gumb +, da podaljšate želeni čas (držite pritisnjeno hitri način).
- ➔ Pritisnite tipko +, da skrajšate želeni čas (držite pritisnjeno hitri način).

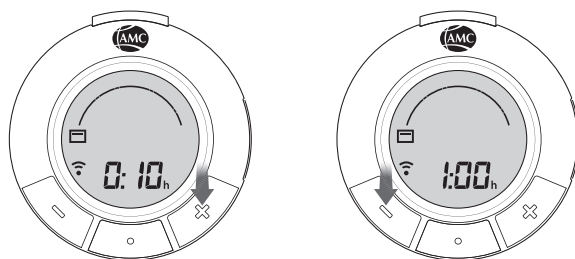

2.4.5 Nastavitev opozorilnika

➔ Vklonite in pritisnite srednji gumb.

Primer: Audiotherm ni nameščen.

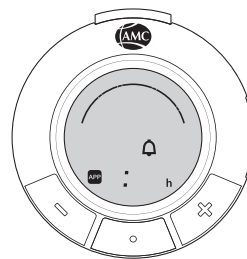

➔ Pritisnite gumb **+**, da podaljšate želeni čas (držite pritisnjeno za hitri način)

ali

➔ Pritisnite tipko **-**, da skrajšate želeni čas (držite pritisnjeno hitri način)

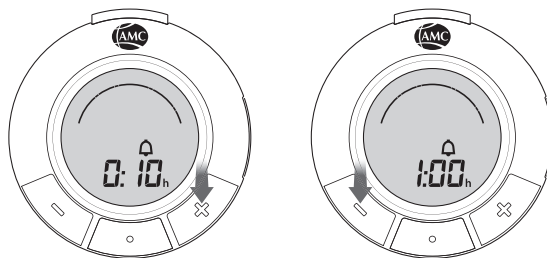

Upoštevajte opise in nasvete v poglavju „AMC metode kuhanja“.

2.4.6 Izbira programov kuhanja

➔ S pritiskom srednjega gumba lahko izberete programe kuhanja.

Primer: Audiotherm je nameščen na Visiothermu.

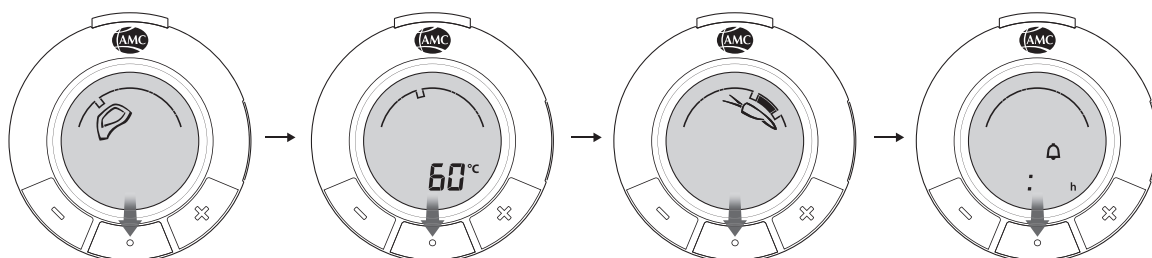

Programe lahko izberete pred ali po namestitvi Audiotherma na Visiotherm.

2.4.7 Izklop opozorilnega zvoka

- ➔ Pritisnite poljubni gumb.
V nasprotnem primeru se opozorilni zvok po 1 minuti izklopi.

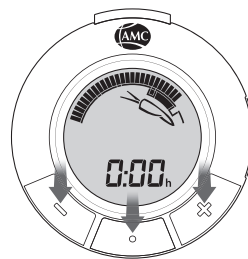

2.4.8 Odstranitev Audiotherma z Visiotherma

- ➔ Pritisnite gumb za zaklepanje in snemite Audiotherm.

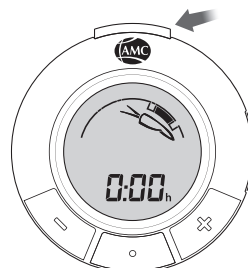

2.4.9 Izklop Audiotherma

- ➔ Srednji gumb pridržite pribl. 2 sekundi.

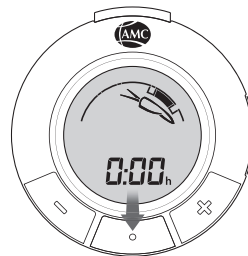

Audiotherm po uporabi vedno snemite z Visiotherma ter ga nikoli ne namakajte v vodi in ne dajajte v pomivalni stroj.

2.5 Dodatne funkcije

2.5.1 Sprememba zvoka

- ➔ Vklomite.
- ➔ Hkrati pritisnite gumb **+** in srednji gumb.

- Izbrati je mogoče melodijo (S: 1) ali pisk (S: 2).

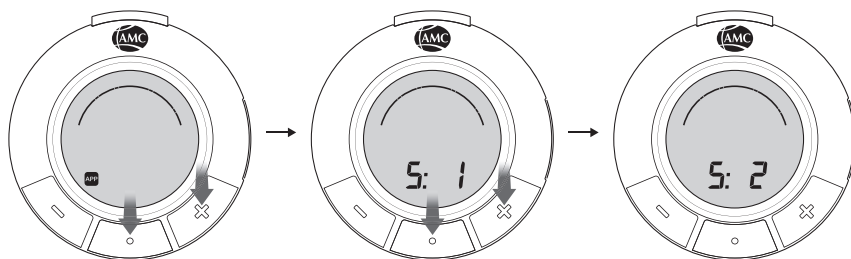

2.5.2 Način za slabovidne osebe

Audiotherm ima način za slabovidne osebe (S: 0). Tega je mogoče aktivirati z aplikacijo Audiotherm. V tem načinu se pri izbiri programov kuhanja za vsak program kuhanja predvaja drugo zaporedje zvokov. Poleg tega je signal za „Povečanje stopnje“ (+) in „Zmanjšanje stopnje“ (−) različen. Vsi drugi signali ustrezajo načinu „Pisk“ (S: 2).

2.5.3 Prikaz različice programske in strojne opreme

➔ Hkrati pritisnite gumb - in srednji gumb ter ju pridržite.

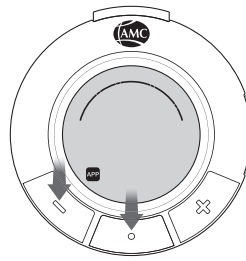

- Po kratkem prikazu vseh simbolov na prikazovalniku se prikaže številka različice programske opreme (npr. 012) in za njo številka različice strojne opreme (npr. H01).

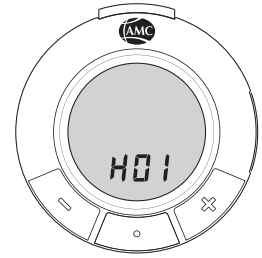

3. Kaj storiti, če...

...je izbran program kuhanja, ki na uporabljenem Visiothermu ni na voljo?

Pri namestitvi Audiotherma se zasliši zvok za napako in predhodno izbrani program kuhanja na prikazovalniku ugasne.

➔ Preverite, v katerem programu je možno kuhati.

...Audiotherm, nastavljen na program, izgubi stik z Visiothermom?

Zasliši se zvok za napako.

➔ Poskrbite, da se Audiotherm ponovno pravilno zaskoči v Visiotherm.

...se prikažejo naslednja sporočila o napakah?

E: 01

Napaka v strojni opremi Audiotherm.

➔ Obrnite se na službo za pomoč uporabnikom.

E: 02

➔ Preverite, ali so vse komponente pravilno nameščene, in ponovno zaženite postopek kuhanja.

E: 03

- ➔ Izklopite Audiotherm. Iz okolja odstranite morebitne vire motenj magneta.
- ➔ Vključite Audiotherm in ponovno zaženite postopek kuhanja.
- ➔ Če se napaka ponovno pojavi, se obrnite na službo za pomoč uporabnikom.

E: 04

Napaka v strojni opremi Navigenio.

➔ Obrnite se na službo za pomoč uporabnikom.

4. Nega in čiščenje

- Audiotherm samo obrišite s krpo, navlaženo z malo tekoče vode.
- Audiotherm redno negujte in čistite, da sta zagotovljena ustržno delovanje in varnost.
- Če Audiotherm pade v vodo:
 - ➔ Audiotherm takoj izklopite. Odprite predalček za bateriji, odstranite bateriji, vidno vodo s krpo obrišite do suhega. Odprti Audiotherm in predalček za baterije pustite, da se sušita najmanj 2 dni.



5. Audiotherm in aplikacija

Audiotherm je mogoče upravljati z aplikacijo.

6. Odstranitev



Embalaža, Audiotherm in Visiotherm ne spadajo med gospodinjске odpadke. Materiali so primerni za reciklažo. Odstranite na okolju prijazen način in ustrezno lokalnim predpisom na primernih izbirnih mestih.

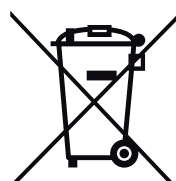

7. Tehnični podatki

- 1,5 V baterije velikosti AAA/LR03/Micro (npr. Alkaline)
- 1,2 V baterije za ponovno polnjenje iste velikosti (npr. NiMH)



8. Izjava o skladnosti

Audiotherm izpolnjuje zahteve CE v skladu z evropsko Direktivo o radijski opremi 2014/53/EU. Celotno izjavo o skladnosti prejmete na naslovu, ki je naveden spodaj v razdelku „AMC služba za pomoč uporabnikom“.

9. AMC služba za pomoč uporabnikom

Če imate vprašanja ali pobude se obrnite na AMC službo za pomoč uporabnikom.

Pomoč uporabnikom

AMC Slovenija
Dunajska cesta 185
1000 Ljubljana
Slovenija

+386 1 519 03 34

AMC Visiotherm a Audiotherm

Návod na použitie

Obsah

1. Visiotherm	
1.1 Používanie v súlade s určením a bezpečnosť	108
1.1.1 Vhodné pokrievky	108
1.1.2 Bezpečnosť	108
1.2 Konštrukcia a ukazovateľ	108
1.3 Montáž a uvedenie do prevádzky	108
1.4 Ošetrovanie a čistenie	109
2. Audiotherm	
2.1 Používanie v súlade s určením a bezpečnosť	109
2.2 Uvedenie Audiothermu do prevádzky a výmena batérií	110
2.3 Konštrukcia a displej	111
2.3.1 Konštrukcia	111
2.3.2 Displej	111
2.4 Funkcie	111
2.4.1 Nasadenie na Visiotherm	112
2.4.2 Zapnutie	112
2.4.3 Nastavenie času	113
2.4.4 Zapekanie a pečenie s kontrolou času	114
2.4.5 Nastavenie kuchynského časovača	115
2.4.6 Nastavenie programu varenia	115
2.4.7 Vypnutie signálneho tónu	116
2.4.8 Zloženie Audiothermu z Visiothermu	116
2.4.9 Vypnutie Audiothermu	116
2.5 Dopĺňujúce funkcie	116
2.5.1 Zmena tónu	116
2.5.2 Režim pre zrakovo postihnuté osoby	116
2.5.3 Zobrazenie softvéru a hardvéru	117
3. Čo robiť, keď...	117
4. Ošetrovanie a čistenie	118
5. Audiotherm a aplikácia	118
6. Likvidácia	118
7. Technické údaje	118
8. Vyhlásenie o zhode	118
9. Zákaznícky servis AMC	118

Visiotherm a Audiotherm sú určené výlučne na používanie v domácnosti a v súlade s určením. Pri neodbornom používaní môžu vzniknúť nebezpečenstvá.

Predtým, ako začnete Visiotherm a Audiotherm používať, pozorne si prečítajte návod na použitie – predovšetkým pokyny na používanie v súlade s určením a pokyny pre bezpečnosť. Uschovajte si návod na použitie a poskytnite ho ďalším majiteľom.

Pozorne si tiež prečítajte brožúru „Varenie s AMC“ a príslušné návody na použitie ďalších produktov AMC, ktoré tiež využíváte.

Význam symbolov



Pokyny dôležité z hľadiska bezpečnosti. Nedodržovanie môže viesť k zraneniam alebo škodám.



Zlý prevádzkový stav alebo nesprávne používanie.



Dobrý prevádzkový stav alebo správne používanie.



Užitočné informácie pre používateľa.



Informácie týkajúce sa ochrany životného prostredia, ekológie a hospodárnosti.



Pracovné kroky sú zvýraznené šípkou.

Verzia návodu na použitie pre Visiotherm a Audiotherm: 07/2020

1. Visiotherm

Visiotherm na pokrievkach AMC meria teplotu v nádobe a panvici a zobrazuje ju na displeji. Visiotherm tak vizuálne ukazuje, či je v nádobe alebo v panvici požadovaná teplota.

1.1 Používanie v súlade s určením a bezpečnosť

1.1.1 Vhodné pokrievky

Visiotherm je vhodný na všetky pokrievky nádob a panvíc AMC.



1.1.2 Bezpečnosť

- Nezabúdajte na nebezpečenstvá v dôsledku vysokej teploty, horúcu pokrievku chytajte len za Visiotherm.
- Visiotherm je vybavený magnetom na prenos teploty. Ak je kardiostimulátor vo vzdialenosti menej ako 2 cm od prízoru Visiothermu, môže sa prepnúť do testovacieho režimu a spôsobiť nevoľnosť.
- Ak sú kreditné karty, EC karty, dátové nosiče, načúvacie prístroje alebo mechanické hodinky vzdialené menej ako 2 cm od prízoru Visiothermu, môžu sa poškodiť.
- Visiotherm nepoužívajte v rúre na pečenie ani v mikrovlnnej rúre.

1.2 Konštrukcia a ukazovateľ

- 1 Ukazovateľ
- 2 Okienko pečenia
- 3 Bod obrátenia
- 4 Okienko zeleniny
- 5 Teplotná stupnica pre zeleninu
- 6 Okienko STOP

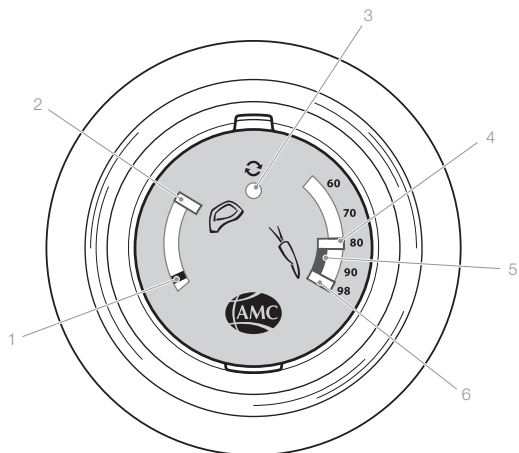

Riadte sa opismi a tipmi v brožúre „Varenie s AMC“.

1.3 Montáž a uvedenie do prevádzky

- ➔ Visiotherm pred prvým uvedením do prevádzky utrite vlhkou handričkou.
- ➔ Naskrutkujte Visiotherm na pokrievku.

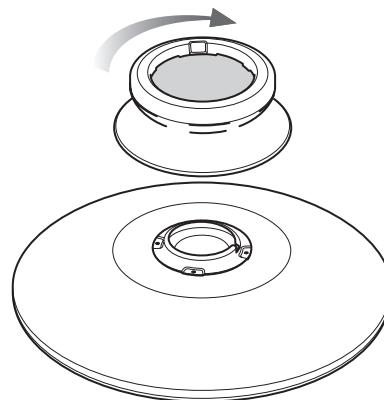

1.4 Ošetrovanie a čistenie

- ➔ Visiotherm odskrutkujte z pokrievky a oba diely vyčistite v umývačke riadu alebo ručne.
- ➔ Pri umývaní v umývačke riadu použite bežný čistiaci prostriedok do umývačky.
- ➔ Pri čistení rukou použite handričku na umývanie alebo mäkkú hubku a neutrálny prostriedok na čistenie riadu.



2. Audiotherm

2.1 Používanie v súlade s určením a bezpečnosť

Audiotherm monitoruje spolu s Visiothermom proces varenia. Audiotherm ukazuje teplotu v nádobe nameranú Visiothermom a slúži ako akustické monitorovanie teploty a doby varenia, a tiež ako ovládanie pri kontrolovanom varení s Navigeniom.

Vhodné pokrievky

- Pokrievka s Visiothermom
- Naparovacia pokrievka EasyQuick s Visiothermom E
- Rýchlovarná pokrievka „Secuquick softline“ s Visiothermom S



Predchádzajte poškodeniam a nesprávnemu používaniu.

- Audiotherm nepoužívajte v rúre na pečenie ani v mikrovlnnej rúre a nevystavujte ho teplotám vyšším ako 70 °C.
- Audiotherm nikdy neponárajte do vody ani ho nevkładajte do umývačky riadu.
- Audiotherm slúži na monitorovanie alebo ovládanie procesu varenia. Audiotherm používajte len na tento účel. Pri nesprávnom používaní môžu vzniknúť nebezpečenstvá.
- Audiotherm obsahuje batérie. Batérie sa nesmú dostať do rúk detí, pretože ich môžu prehltnúť.
- Používajte len batérie odporúčaného a rovnakého druhu (podľa kapitoly 5).
- Nikdy sa nepokúšajte dobiť nenabíjateľné batérie.

Riadte sa tiež návodmi na použitie pre EasyQuick, Secuquick softline a Navigenio, ako aj pokynmi a tipmi v brožúre „Varenie s AMC“.



Dohľad

- Na proces varenia sa musí dozerať. Pri akustickom monitorovaní procesu varenie používajte Audiotherm len vo vzdialenosti, v ktorej budete signály počuť.
- Nekontrolované varenie bez dohľadu môže viesť k prehriatiu. Pokrmu sa môžu pokaziť a nádoba sa môže poškodiť alebo zničiť. Hrozí nebezpečenstvo úrazu a vzniku požiaru.
- Deti staršie ako 8 rokov alebo osoby s obmedzenými telesnými, zmyslovými alebo duševnými schopnosťami, resp. s nedostatkom skúseností alebo vedomostí smú používať zariadenie. Musia byť však pod dohľadom alebo poučené o bezpečnom používaní zariadenia a z toho vyplývajúcich nebezpečenstvách. Týka sa to aj akustického monitorovania zrakovo postihnutými osobami (pozri kapitolu 2.5.2).

2.2 Uvedenie Audiothermu do prevádzky a výmena batérií

Uvedenie do prevádzky:

Súčasťou balenia Audiothermu sú dve batérie (typ podľa kapitoly 5).

Vložte batérie, aby ste zariadenie uviedli do prevádzky.

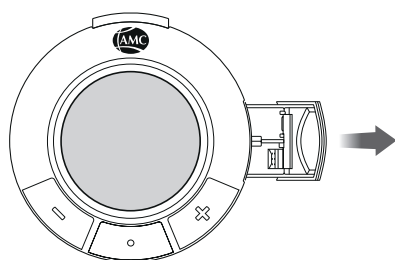

➔ Otvorte priehradku na batérie a vytiahnite držiak batérií.

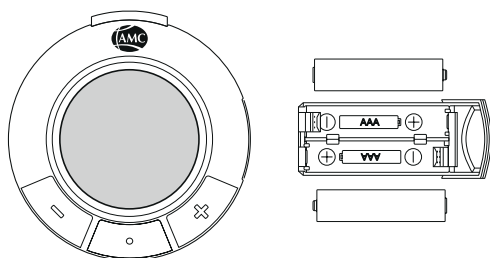

➔ Batérie správne vložte podľa vyobrazenia.

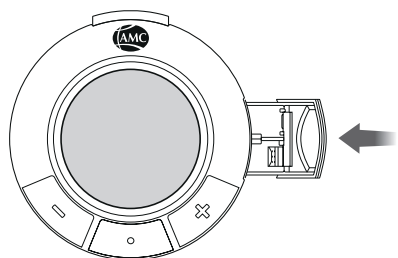

➔ Držiak batérií zasuňte do Audiothermu a zatvorte tak, aby ste pritom počuli „kliknutie“.

Výmena batérií:

Ak je na displeji viditeľný indikátor stavu batérie, batérie včas vymeňte.



Spotrebované batérie zlikvidujte v súlade s miestnymi predpismi!

2.3 Konštrukcia a displej

2.3.1 Konštrukcia

- 1 Tlačidlo odomknutia
- 2 Tlačidlo **—**
- 3 Stredné tlačidlo
- 4 Tlačidlo **+**

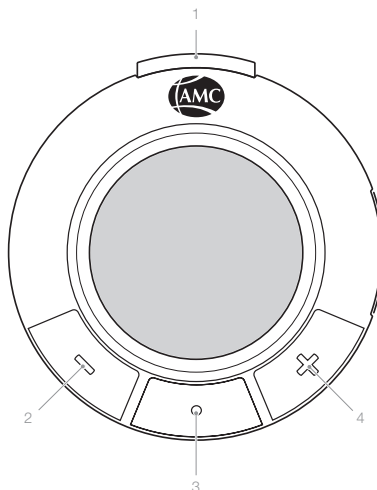

2.3.2. Displej

- 1 Symbol soft
- 2 Symbol pečenie
- 3 Symbol zelenina
- 4 Základná línia
- 5 Symbol bodu obrátenia
- 6 Bod obrátenia
- 7 Symbol naparovania
- 8 Symbol 60 °C
- 9 Ukazovateľ mínus

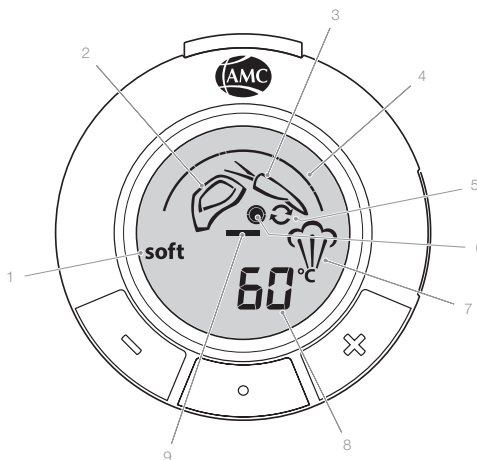

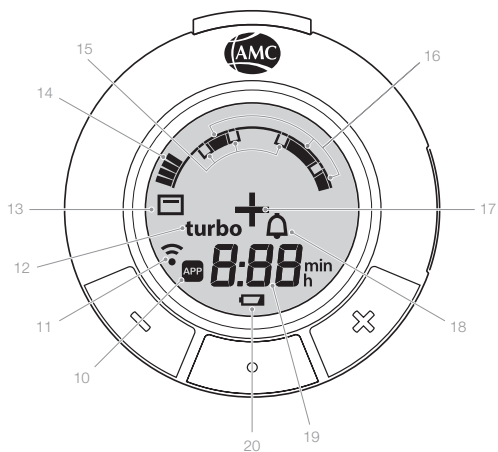

- 10 Pripojenie aplikácie
- 11 Pripojenie Navigenia
- 12 Symbol turbo
- 13 Symbol pečenia
- 14 Teplotná stupnica
- 15 Body vyžadujúce zásah
- 16 Teplotné rozsahy
- 17 Ukazovateľ plus
- 18 Symbol kuchynského časovača
- 19 Zobrazenie času
- 20 Indikátor stavu batérie



2.4 Funkcie

System varenia AMC zahŕňa rôzne metódy varenia. Audiotherm je pritom možné používať dvoma spôsobmi.

Manuálne varenie s Visiothermom a Audiothermom:

- Audiotherm zobrazuje aktuálnu teplotu a prostredníctvom signálnych tónov  upozorňuje používateľa, keď je potrebný zásah. Na displeji zobrazuje, aký zásah je potrebné vykonať.
- Signálnym tónom  upozorňuje Audiotherm na to, že doba varenia uplynula.
- Varnú platňu obsluhuje používateľ.

Kontrolované varenie:

Pri varení na mobilnej varnej platni „Navigenio“ umožňuje Audiotherm kontrolované varenie.

- Prostredníctvom bezdrôtového spojenia s Navigeniom kontroluje Audiotherm automaticky celý proces varenia.
- Po zapnutí Navigenia do režimu „A“ prevezme ovládanie Navigenia Audiotherm.
- Signálnym tónom  upozorňuje Audiotherm na to, že zadaná doba varenia uplynula.



Všetky funkcie varenia (výnimka: plánované varenie a program 60 °C) je možné vykonávať ručne alebo aj kontrolované.

Riadte sa opismi a tipmi v časti „Metódy varenia AMC“.

2.4.1 Nasadenie na Visiotherm

- ➔ Nasadte Audiotherm na Visiotherm tlačidlom smerujúcim nahor a nechajte ho zapadnúť tak, aby ste pritom počuli „kliknutie“.

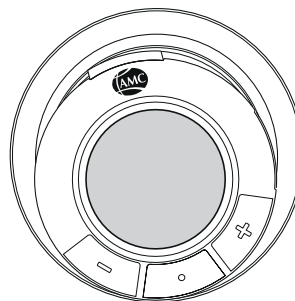

2.4.2 Zapnutie

- ➔ Stlačte ľubovoľné tlačidlo.

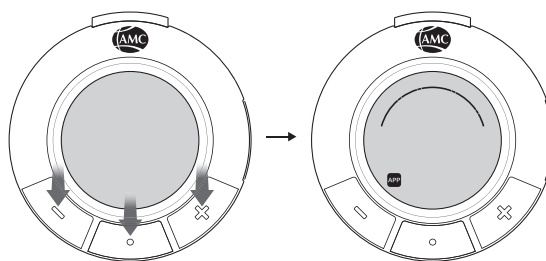

2.4.3 Nastavenie času



Čas je možné nastaviť predtým alebo potom, ako sa Audiotherm nasadí na Visiotherm, resp. predtým alebo potom, ako sa vyberie príslušný program varenia. Všetky časy, ktoré sa zobrazia pri prvom stlačení tlačidiel, sú prednastavené hodnoty, ktoré uľahčujú zadávanie.

Doba varenia

Na monitorovanie doby varenia je možné zadať čas v Audiotherme. Nastavená doba varenia začne ubiehať, len čo sa dosiahne príslušná teplota varenia.

➔ Zapnite.

➔ Stlačte tlačidlo **+**, aby ste navolili krátku dobu (0:10) alebo predĺžili požadovanú dobu varenia (pre rýchly chod podržte stlačené),

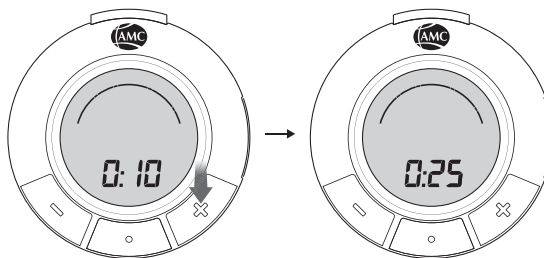

alebo

➔ Stlačte tlačidlo **-**, aby ste navolili dlhú dobu (1:00) alebo skrátili požadovanú dobu varenia (pre rýchly chod podržte stlačené).

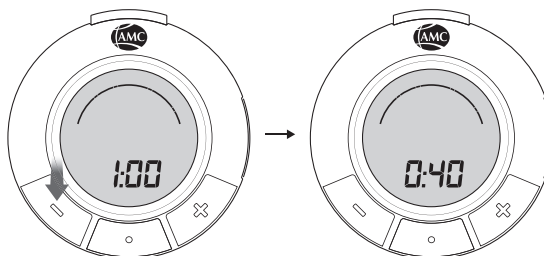

Nastavenie času „P“

➔ Po zapnutí stlačte tlačidlo **-** a potom tlačidlo **+**.

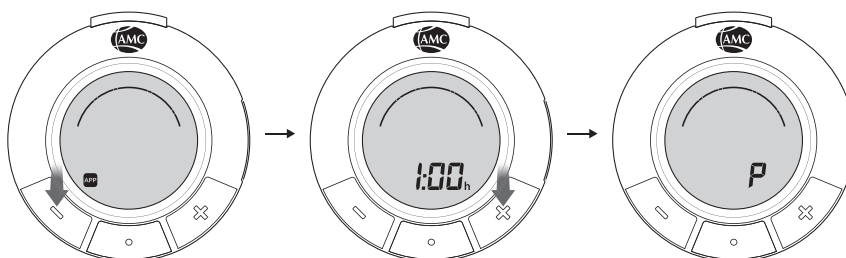

Bez zadania času kontroluje Audiotherm teplotu pre požadovaný proces varenia bez časového obmedzenia. Dobu varenia je možné nastaviť aj spustením procesu varenia a meniť ju po celú dobu prevádzky.

Riadte sa opismi a tipmi v časti „Metódy varenia AMC“.

Plánované varenie „+“

Audiotherm je možné v kontrolovanej prevádzke s Navigeniom nastaviť na úroveň „A“ tak, aby proces varenia začal neskôr (oneskorenie spustenia).

➔ Zapnite a zadajte dobu varenia.

- Len čo sa na displeji zobrazí „+“,

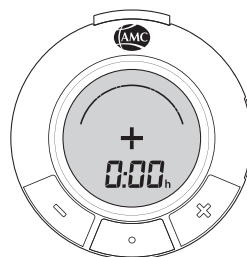

➔ Stlačte tlačidlo +, aby ste navolili krátky čas oneskorenia spustenia (1:00) alebo predĺžili požadovaný čas (pre rýchly chod podržte stlačené),

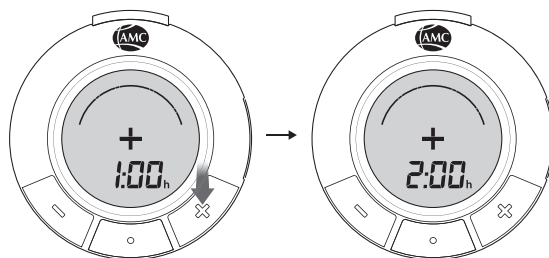

alebo

➔ Stlačte tlačidlo -, aby ste navolili dlhý čas oneskorenia spustenia (8:00) alebo skrátili požadovaný čas (pre rýchly chod podržte stlačené).

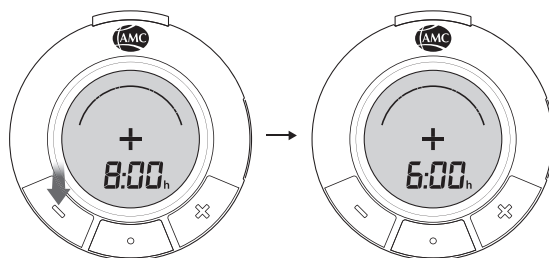

- Na displeji sa striedavo zobrazuje doba varenia a čas oneskorenia spustenia so symbolom „+“.



Nastavený čas oneskorenia spustenia môžete meniť počas celej prevádzky. Čas oneskoreného spustenia alebo dobu varenia môžete kedykoľvek zmeniť, pokiaľ je táto možnosť zobrazená na displeji.

Riadte sa opismi a tipmi v časti „Metódy varenia AMC“.

2.4.4 Zapekanie a pečenie s kontrolou času

Na monitorovanie času môžete zadať čas v Audiotherme. Čas je možné zadať, pokiaľ Navigenio zapnuté na požadovanom stupni bliká striedavo modrou/červenou farbou.

➔ Stláčajte stredné tlačidlo, až sa zobrazí symbol pečenia.

➔ Stlačte tlačidlo +, aby ste predĺžili požadovaný čas (pre rýchly chod podržte stlačené).

➔ Stlačte tlačidlo -, aby ste skrátili požadovaný čas (pre rýchly chod podržte stlačené).

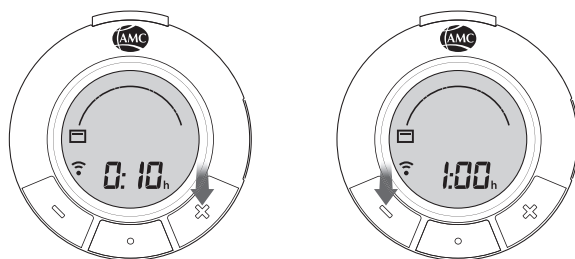

2.4.5 Nastavenie kuchynského časovača

- ➔ Zapnite a stlačte stredné tlačidlo.

Príklad: Audiotherm nie je nasadený.

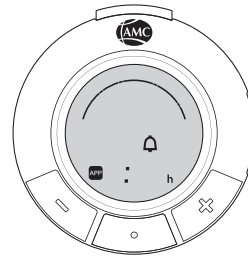

- ➔ Stlačte tlačidlo **+**, aby ste predĺžili požadovaný čas (pre rýchly chod podržte stlačené),

alebo

- ➔ Stlačte tlačidlo **-**, aby ste skrátili požadovaný čas (pre rýchly chod podržte stlačené)

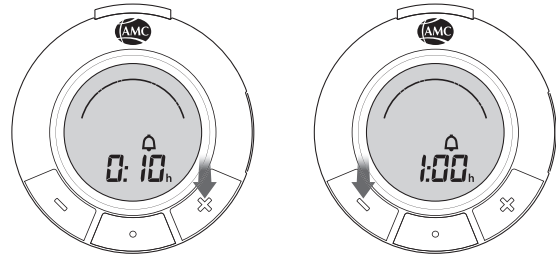

Riadte sa opismi a tipmi v časti „Metódy varenia AMC“.

2.4.6 Výber programov varenia

- ➔ Stláčaním stredného tlačidla môžete vyberať programy varenia.

Príklad: Audiotherm je nasadený na Visiotherme.

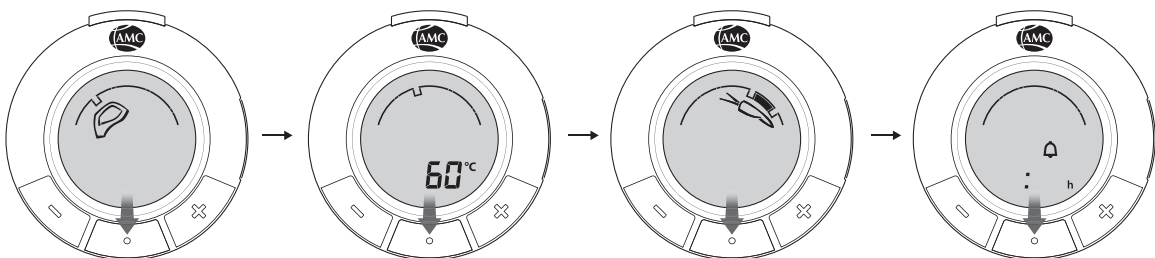

Programy môžete vyberať predtým alebo potom, ako sa Audiotherm nasadí na Visiotherm.

2.4.7 Vypnutie signálneho tónu

- ➔ Stlačte ľubovoľné tlačidlo.
- V opačnom prípade sa signálny tón vypne po 1 minúte.

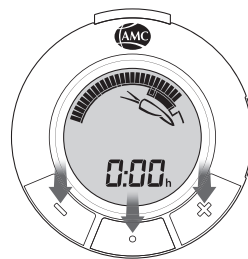

2.4.8 Zloženie Audiothermu z Visiothermu

- ➔ Stlačte tlačidlo odomknutia a zložte Audiotherm.

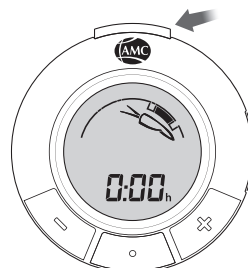

2.4.9 Vypnutie Audiothermu

- ➔ Stredné tlačidlo podržte stlačené cca 2 sekundy.

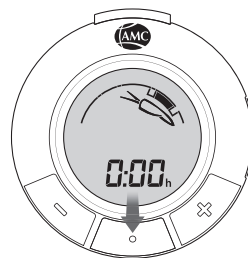

Audiotherm po používaní vždy zložte z Visiothermu a nikdy ho neponárajte do vody ani nevkladajte do umývačky riadu.

2.5 Doplnujúce funkcie

2.5.1 Zmena tónu

- ➔ Zapnite.
- ➔ Súčasne stláčajte tlačidlo **+** a stredné tlačidlo.

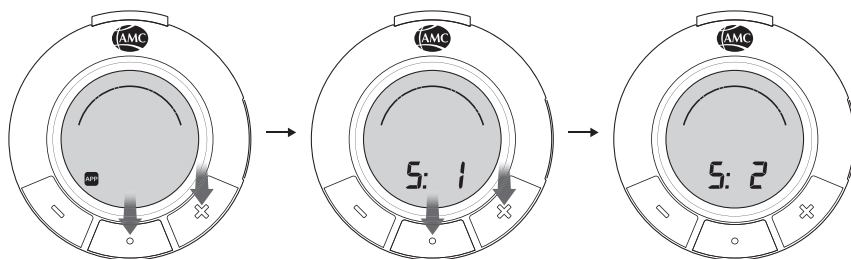

- Môžete vybrať melódiu (S: 1) alebo tón pípania (S: 2).

2.5.2 Režim pre zrakovo postihnuté osoby

Audiotherm disponuje režimom pre zrakovo postihnuté osoby (S: 0). Môžete ho aktivovať aplikáciou Audiothermu. V tomto režime sa pri výbere programov varenia prehrá pre každý program varenia iný sled tónov. Navyše je signál pre „Zvýšenie stupňa ohrevu“ (+) a „Zníženie stupňa ohrevu“ (-) odlišný. Všetky ostatné signály zodpovedajú režimu „Tón pípania“ (S: 2).

2.5.3 Zobrazenie softvéru a hardvéru

➔ Súčasne stlačte tlačidlo  a stredné tlačidlo a držte stlačené.

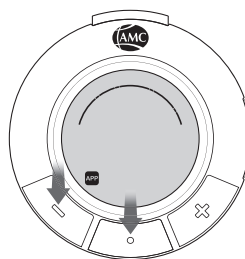

■ Po krátkom zobrazení všetkých symbolov na displeji sa zobrazí číslo softvéru (napr. 012) a potom číslo hardvéru (napr. H01).

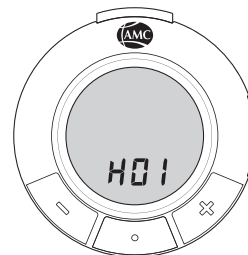
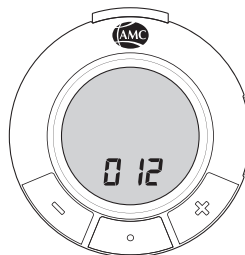

3. Čo robiť, keď...

...je zvolený program varenia, ktorý nie je k dispozícii na používanom Visiotherme?

Po nasadení Audiothermu zaznie chybový tón a predtým zvolený program varenia zmizne z displeja.

➔ Skontrolujte, v ktorom programe sa má variť.

...Audiotherm nastavený na program stratí kontakt s Visiothermom?

Zaznie chybový tón.

➔ Audiotherm nechajte opäť správne zapadnúť do Visiothermu.

...sa zobrazujú nasledujúce chybové hlásenia?

E: 01

Chyba v hardvéri Audiothermu.

➔ Kontaktujte zákaznícky servis.

E: 02

➔ Skontrolujte, či sú všetky komponenty správne nasadené, a znova spustite proces varenia.

E: 03

- ➔ Vypnite Audiotherm. Odstráňte prípadné zdroje magnetického rušenia z okolia.
- ➔ Zapnite Audiotherm a znova spustite proces varenia.
- ➔ Ak sa chyba vyskytne opakovane, kontaktujte zákaznícky servis.

E: 04

Chyba v hardvéri Navigenio.

➔ Kontaktujte zákaznícky servis.

4. Ošetrovanie a čistenie

- Audiotherm utierajte iba handričkou navlhčenou v troche vody na umývanie.
- Ošetrujte a čistite Audiotherm pravidelne, aby ste zaistili funkčnosť a bezpečnosť.
- Ak Audiotherm spadne do vody:
 - ➔ Audiotherm okamžite vypnite. Otvorte priehradku na batérie, odstráňte batérie, viditeľnú vodu osušte handričkou. Otvorený Audiotherm a priehradku na batérie nechajte schnúť najmenej 2 dni.



5. Audiotherm a aplikácia

Audiotherm môžete ovládať prostredníctvom aplikácie.

6. Likvidácia



Obal, Audiotherm a Visiotherm nepatria do domového odpadu. Materiály sú recyklovateľné. Výrobok zlikvidujte ekologickým spôsobom a v súlade s miestnymi predpismi na vhodných zberných miestach.



7. Technické údaje

- 1,5 V batérie veľkosti AAA/LR03/micro (napr. alkaline)
- Nabíjateľné 1,2 V batérie rovnakej veľkosti (napr. NiMH)



8. Vyhlásenie o zhode

Audiotherm spĺňa požiadavky CE v súlade s európskou smernicou o rádiových zariadeniach 2014/53/EÚ. Úplné vyhlásenie o zhode nájdete na adrese uvedenej v časti „Zákaznícky servis AMC“.

9. Zákaznícky servis AMC

V prípade akýchkoľvek otázok alebo podnetov kontaktujte zákaznícky servis AMC.

Zákaznícky servis

AMC na Slovensku
Orechový rad 6, 821 05
Bratislava

+421 905 624 659

AMC Visiotherm & Audiotherm

Kullanma Talimatı

İçindekiler

1. Visiotherm	
1.1 Amaca uygun kullanım ve güvenlik	121
1.1.1 Uygun kapaklar	121
1.1.2 Güvenlik	121
1.2 Kurulum ve gösterge	121
1.3 Montaj ve ilk kullanım	121
1.4 Bakım ve temizlik	122
2. Audiotherm	
2.1 Amaca uygun kullanım ve güvenlik	122
2.2 Audiotherm'in ilk kullanımı ve pil değişimi	123
2.3 Kurulum ve ekran	124
2.3.1 Kurulum	124
2.3.2 Ekran	124
2.4 İşlevler	125
2.4.1 Visiotherm'in üzerine yerleştirme	125
2.4.2 Çalıştırma	125
2.4.3 Zaman ayarı	126
2.4.4 Zaman kontrollü gratenleme ve pişirme	127
2.4.5 Mutfak alarmı ayarı	128
2.4.6 Pişirme programı seçimi	128
2.4.7 Sinyal sesini kapatma	129
2.4.8 Audiotherm'i Visiotherm'den alma	129
2.4.9 Audiotherm'i kapatma	129
2.5 İlave işlevler	129
2.5.1 Sesi değiştirme	129
2.5.2 Görme engelliler için mod	129
2.5.3 Yazılımı ve donanımı görüntüleme	130
3. Ne yapmalı...	130
4. Bakım ve temizlik	131
5. Audiotherm ve uygulama	131
6. Elden çıkarma	131
7. Teknik veriler	131
8. Uygunluk beyanı	131
9. AMC müşteri hizmetleri	131

Visiotherm ve Audiotherm sadece normal ev işleri ve amacına uygun kullanım için tasarlanmıştır. Uygunsuz kullanım tehlikeler doğurabilir.

Lütfen Visiotherm ve Audiotherm'i kullanmadan önce, özellikle amaca uygun kullanım ve güvenlik bilgileri olmak üzere kullanma talimatını dikkatle okuyun. Kullanma talimatını saklayın ve ürünün bir sonraki sahiplerine verin.

Bunun yanı sıra, „AMC ile pişirme“ broşürünü ve birlikte kullanılacak ilgili AMC ürünlerinin ilgili kullanma talimatlarını da dikkatle okuyun.

Simgelerin anlamı



Güvenlik için önemli talimatlar. Dikkate alınmaması yaralanmaya ya da hasarlara yol açabilir.



Kötü kullanım durumu ya da uygunsuz kullanım.



İyi kullanım durumu ya da uygun kullanım.



Yararlı kullanıcı notları.



Çevre koruma, ekoloji ve ekonomiyle ilgili notlar.



Çalışma aşamaları bir okla vurgulanmıştır.

Visiotherm ve Audiotherm kullanma talimatı sürümü: 07/2020

1. Visiotherm

AMC kapaklarının üzerindeki Visiotherm tenceredeki ve tavadaki sıcaklığı ölçer ve ekranda gösterir. Visiotherm, tencerede veya tavada istenilen sıcaklığın mevcut olup olmadığını görsel olarak gösterir.

1.1 Amaca uygun kullanım ve güvenlik

1.1.1 Uygun kapaklar

Visiotherm tüm AMC tencere ve tavalarının kapakları için uygundur.



1.1.2 Güvenlik

- Sıcaktan kaynaklanan tehlikelere dikkat edin, sıcak kapakları sadece Visiotherm'den tutun.
- Visiotherm ısının iletilmesi için bir miktarla donatılmıştır. Visiotherm kontrol camına 2 cm'den daha az mesafede olması durumunda, kalp pili test moduna geçebilir ve rahatsızlığa neden olabilir.
- Visiotherm kontrol camına 2 cm'den daha az mesafede olması durumunda, kredi kartları, banka kartları, veri taşıyıcılar, işitme cihazları veya mekanik saatler hasar görebilir
- Visiotherm fırında ya da mikrodalga fırında kullanılmamalıdır.

1.2 Kurulum ve gösterge

- 1 İbre
- 2 Kızartma penceresi
- 3 Döndürme noktası
- 4 Sebze penceresi
- 5 „Sebze“ ısı aralığı
- 6 Durma penceresi

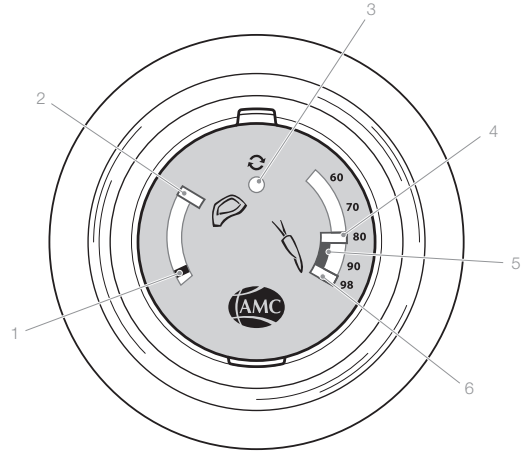

„AMC ile pişirme“ broşüründeki tariflere ve tavsiyelere dikkat edin.

1.3 Montaj ve ilk kullanım

- ➔ Visiotherm'i ilk kullanımdan önce nemli bir bezle silin.
- ➔ Visiotherm'i kapağın üzerine vidalayın.

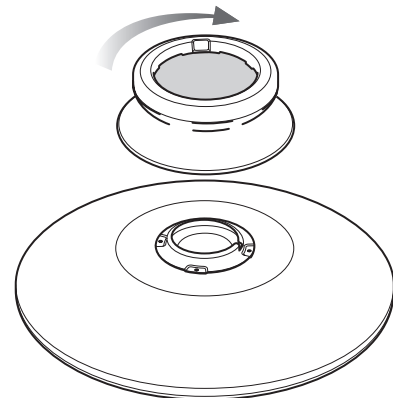

1.4 Bakım ve temizlik

- ➔ Visiotherm'i kapaktan çıkarın ve her ikisini bulaşık makinesinde veya elle temizleyin.
- ➔ Bulaşık makinesi için ev tipi makine deterjanı kullanın.
- ➔ Elde yıkama için silme bezi veya yumuşak sünger ve nötr bulaşık deterjanı kullanın.



2. Audiotherm

2.1 Amaca uygun kullanım ve güvenlik

Audiotherm, Visiotherm ile birlikte pişirme sürecini denetler. Audiotherm, Visiotherm tarafından ölçülen ısıyı gösterir ve sesli ısı ve pişirme süresi denetimi ve Navigenio ile kontrollü pişirmede kumanda işlevi görür.

Uygun kapaklar

- Visiotherm'li kapak
- Visiotherm E ile EasyQuick buharda pişirme kapağı
- Visiotherm S ile „Secuquick Softline“ hızlı pişirme kapağı



Hasarlardan ve uygunsuz kullanmaktan kaçının.

- Audiotherm'i fırında ya da mikrodalga fırında kullanmayın ve 70 C üzeri ısılarla maruz bırakmayın.
- Audiotherm'i asla suya daldırmayın veya bulaşık makinesine koymayın.
- Audiotherm, pişirme işleminin denetlenmesine veya kumanda edilmesine yarar. Audiotherm sadece bu amaç için kullanılmalıdır. Uygunsuz bir kullanım tehlikeler doğurabilir.
- Audiotherm pil içerir. Piller yutulabileceği için çocukların eline geçmemelidir.
- Sadece tavsiye edilen aynı türden piller (Bölüm 5 uyarınca) kullanın.
- Şarj edilemeyen pilleri şarj etmeye çalışmayın.

Lütfen EasyQuick, Secuquick Softline ve Navigenio kullanma talimatlarını ve „AMC ile pişirme“ broşüründeki uyarı ve tavsiyeleri de dikkate alın.



Gözetim

- Pişirme işlemi gözetim altında gerçekleştirilmelidir. Pişirme işleminin sesli denetimi için Audiotherm'i işitme mesafesinde kullanın.
- Gözetimsiz, denetimsiz pişirme aşırı ısınmaya yol açabilir. Yemekler bozulabilir ve tencere hasar görebilir ya da harap olabilir. Kaza ve yangın tehlikesi.
- Cihaz 8 yaş üzeri çocuklarda veya bedensel, duyuusal veya zihinsel becerileri zayıflamış ya da yetersiz bilgi ve deneyime sahip kişilerce kullanılabilir. Ancak bu kişilerin gözlemlenmesi ya da cihazın güvenli kullanımı konusunda bilgilendirilmiş ve bundan kaynaklanacak tehlikeleri anlamış olması gerekir. Bu husus görme engelliler tarafından sesli denetim için de geçerlidir (bkz. Bölüm 2.5.2).

2.2 Audiotherm'in ilk kullanımı ve pil değişimi

İlk kullanım:

Audiotherm'in teslimat kapsamında iki pil mevcuttur (Bölüm 5 uyarınca tip).

İlk kullanım için pilleri yerleştirin.

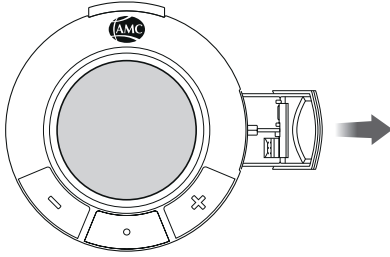

➔ Pil gözünü açın ve pil tutucusunu dışarı çekin.

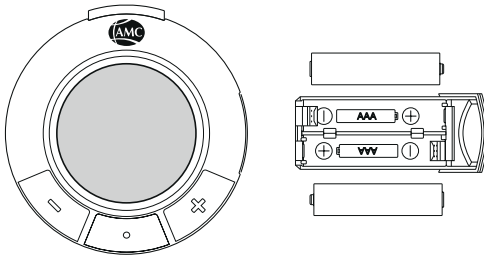

➔ Pilleri resimdeki gibi doğru yerleştirin.

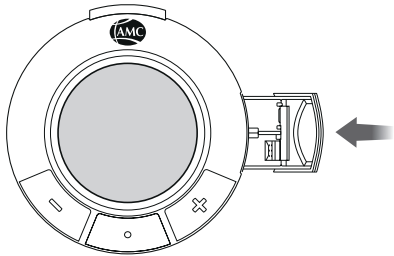

➔ Pil tutucusunu Audiotherm'e yerleştirin ve „Klik“ sesiyle kapatın.

Pil değişimi:

Ekranda pil göstergesi görüldüğünde, piller kısa zamanda değiştirin.



Kullanılmış pilleri ilgili yerel kurallara göre bertaraf edin!

2.3 Kurulum ve ekran

2.3.1 Kurulum

- 1 Kilit açma tuşu
- 2 —-tuşu
- 3 Orta tuş
- 4 + -tuşu

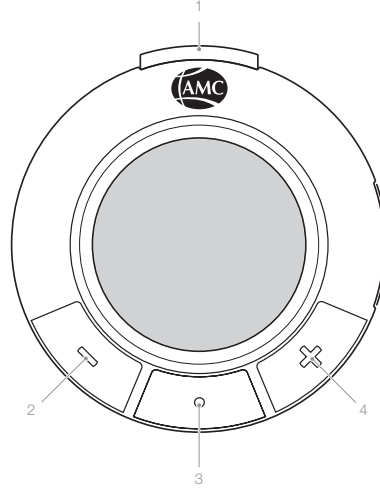

2.3.2. Ekran

- 1 Soft simgesi
- 2 Kızartma simgesi
- 3 Sebze simgesi
- 4 Ana çizgi
- 5 „Döndürme noktası“ simgesi
- 6 Döndürme noktası
- 7 Buhar simgesi
- 8 60°C simgesi
- 9 Eksi göstergesi

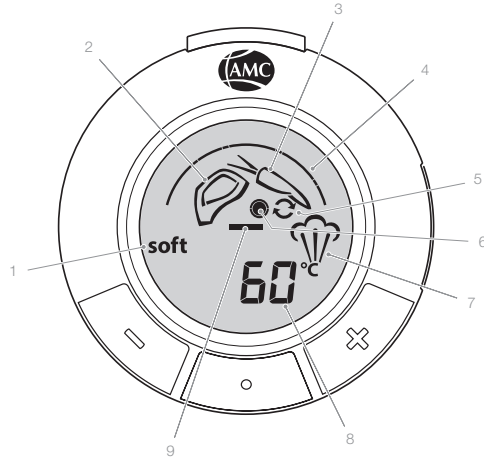

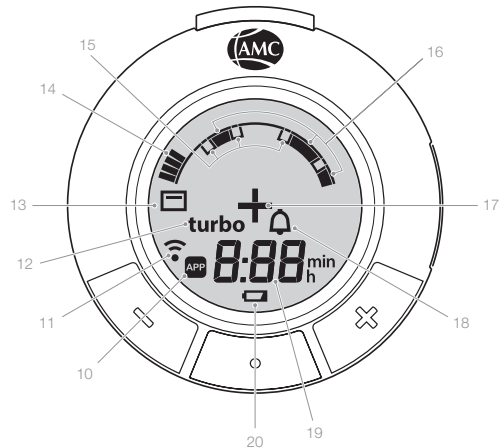

- 10 „App“ bağlantısı
- 11 „Navigenio“ bağlantısı
- 12 Turbo simgesi
- 13 Geri simgesi
- 14 Isı ölçeği
- 15 Hareket noktaları
- 16 Isı aralıkları
- 17 Artı göstergesi
- 18 Mutfak alarmı simgesi
- 19 Zaman göstergesi
- 20 Pil göstergesi



2.4 İşlevler

AMC pişirme sistemi çeşitli pişirme yöntemlerini kapsamaktadır. Bu arada Audiotherm iki farklı şekilde kullanılabilir.

Visiotherm ve Audiotherm ile manuel pişirme:

- Audiotherm güncel ısıyı gösterir ve bir şey yapılması gerektiğini sinyal sesleriyle  belirtir. Ekranda ne yapılması gerektiğini gösterir.
- Audiotherm bir sinyal sesiyle  pişirme süresinin sona erdiğini gösterir.
- Pişirme alanının kullanımı kullanıcı tarafından gerçekleştirilir.

Kontrollü pişirme:

Mobil „Navigenio“ ocakta pişirme esnasında Audiotherm kontrollü pişirme imkânı sunar.

- Audiotherm bütün pişirme sürecini Navigenio ile kablosuz bağlantı üzerinden, bağımsız olarak denetler.
- Navigenio „A“ konumuna alındıktan sonra Navigenio'nun kumandası Audiotherm tarafından devralınır.
- Audiotherm bir sinyal sesiyle  girilen pişirme süresinin sona erdiğini gösterir.



Tüm pişirme işlevleri (istisna: planlı pişirme ve 60 C program) hem manuel hem de kontrollü olarak gerçekleştirilebilir.

„AMC Pişirme Yöntemleri“ içindeki tariflere ve tavsiyelere dikkat edin.

2.4.1 Visiotherm'in üzerine yerleştirme

- ➔ Audiotherm'i basma tuşunu yukarı doğru bacak şeklinde Visiotherm'in üzerine yerleştirin ve bir „Klik“ sesiyle yerine oturtun.

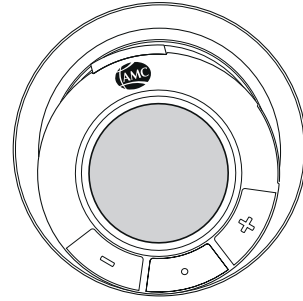

2.4.2 Çalıştırma

- ➔ Herhangi bir tuşa basın.

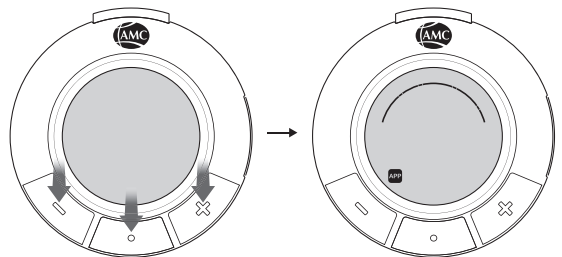

2.4.3 Zaman ayarı



Süreler Audiotherm Visiotherm'in üzerine yerleştirilmeden önce veya sonra ya da ilgili pişirme programı seçilmeden önce veya sonra ayarlanabilir. Tuşlara ilk kez basıldığında gösterilen tüm saatler girişi kolaylaştırmak için önceden ayarlanmış değerlerdir.

Pişirme süresi

Pişirme süresinin izlenmesi için bu süre Audiotherm'e girilebilir. İlgili pişirme ısısına ulaşıldığında ayarlanan pişirme süresi sona ermeye başlar.

➔ Çalıştırın.

➔ **+**-tuşuna kısa bir süre (0:10) seçmek veya istediğiniz pişirme süresini arttırmak (hızlı sayması için basılı tutun) için basın,

ya da

➔ **+**-tuşuna uzun bir süre (1:00) seçmek veya istediğiniz pişirme süresini düşürmek (hızlı sayması için basılı tutun) için basın.

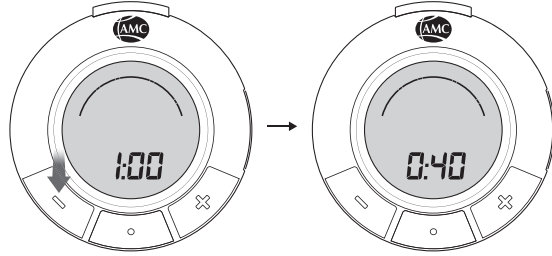
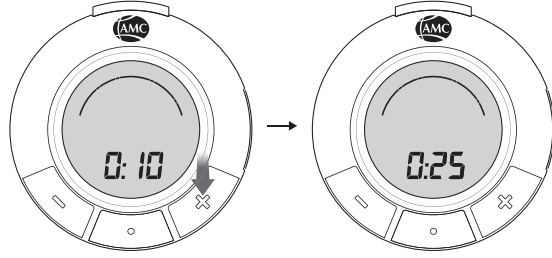

„P“ zaman ayarı

➔ Çalıştırdıktan sonra **-**-tuşuna ve ardından **+**-tuşuna basın.



Zaman girişi yapılmadığında Audiotherm istenilen pişirme işlemi için ısıyı zaman sınırlaması olmadan kontrol eder. Pişirme süresi, pişirme işlemi başladıktan sonra da ayarlanabilir ve tüm pişirme süresi boyunca değiştirilebilir.

„AMC Pişirme Yöntemleri“ içindeki tariflere ve tavsiyelere dikkat edin.

Planlanmış pişirme „+“

Audiotherm, pişirme işlemi daha ileri bir saatte başlayacak şekilde (başlama gecikmesi) kontrollü moda Navigenio ile „A“ kademesine ayarlanabilir.

➔ Çalıştırın ve pişirme süresini girin.

▪ Ekranda „+“ belirdiğinde.



➔ +-tuşuna kısa bir geç başlama süresi (1:00) seçmek veya istediğiniz süreyi arttırmak (hızlı sayması için basılı tutun) için basın,

ya da

➔ +-tuşuna uzun bir geç başlama süresi (8:00) seçmek veya istediğiniz süreyi düşürmek (hızlı sayması için basılı tutun) için basın.

▪ Ekranda pişirme süresi ve geç başlama süresi dönüşümlü olarak „+“ ile gösterilir.

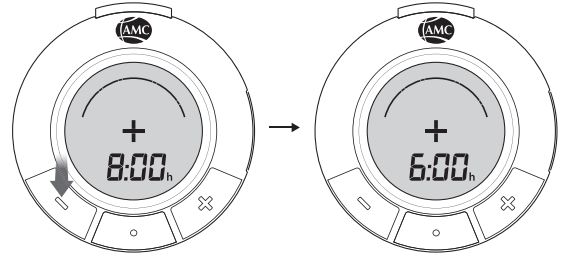
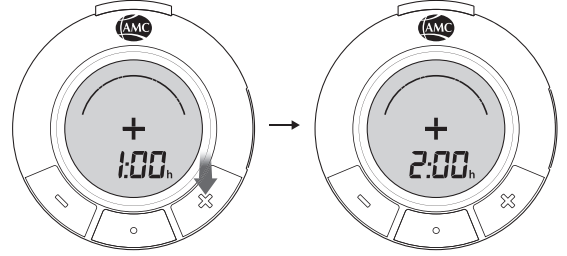

Ayarlanan geç başlama süresi tüm pişirme süresi boyunca değiştirilebilir. Geç başlama süresinin veya pişirme süresinin değişikliği, bu süre ekranda gösterildiği müddetçe her zaman gerçekleştirilebilir.

„AMC Pişirme Yöntemleri“ içindeki tariflere ve tavsiyelere dikkat edin.

2.4.4 Zaman kontrollü gratenleme ve pişirme

Sürenin izlenmesi için bu süre Audiotherm'e girilebilir. İstenilen kademeye açılan Navigenio dönüşümlü olarak mavi/kırmızı yanıp söndüğü müddetçe süre girilebilir.

➔ Geri simgesi belirene kadar orta tuşa basın.

➔ +-tuşuna istediğiniz süreyi arttırmak (hızlı sayması için basılı tutun) için basın.

➔ +-tuşuna istediğiniz süreyi düşürmek (hızlı sayması için basılı tutun) için basın.

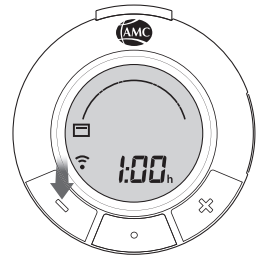
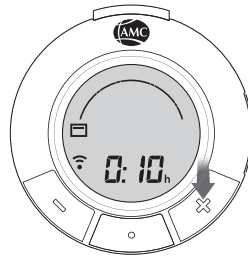

2.4.5 Mutfak alarmı ayarı

- ➔ Çalıştırın ve orta tuşa basın.

Örnek: Audiotherm yerleştirilmemiş.

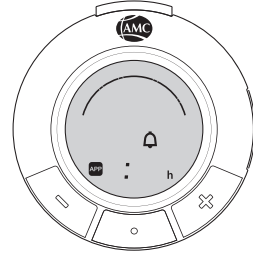

- ➔ **+**-tuşuna istediğiniz süreyi arttırmak (hızlı sayması için basılı tutun) için basın,

ya da

- ➔ **+**-tuşuna istediğiniz süreyi düşürmek (hızlı sayması için basılı tutun) için basın

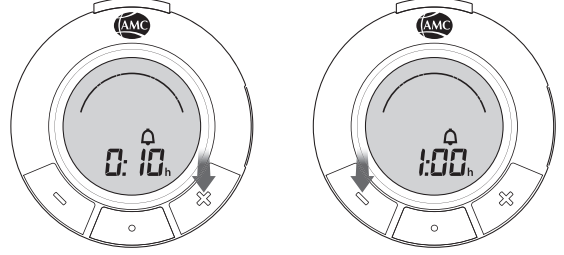

„AMC Pişirme Yöntemleri“ içindeki tariflere ve tavsiyelere dikkat edin.

2.4.6 Pişirme programlarının seçimi

- ➔ Orta tuşa basılarak pişirme programları seçilebilir.

Örnek: Audiotherm, Visiotherm'in üzerine yerleştirilmiş.

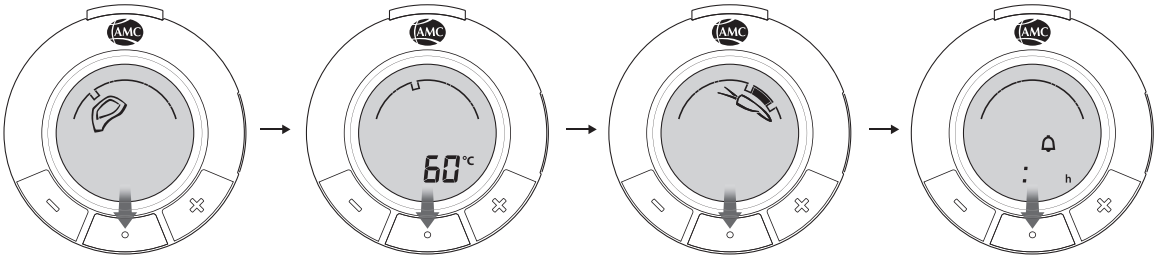

Audiotherm, Visiotherm'in üzerine yerleştirilmeden önce veya sonra programlar seçilebilir.

2.4.7 Sinyal sesini kapatma

- ➔ Herhangi bir tuşa basın.
Aksi halde sinyal sesi 1 dakika sonra kesilir.

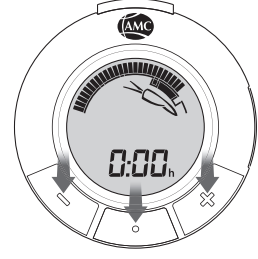

2.4.8 Audiotherm'i Visiotherm'den alma

- ➔ Kilit açma tuşuna basın ve Audiotherm'i alın.



2.4.9 Audiotherm'i kapatma

- ➔ Orta tuşa yakl. 2 saniye basılı tutun.

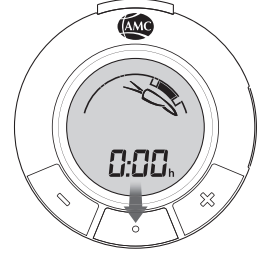

Audiotherm'i kullandıktan sonra daima Visiotherm'den alın ve asla suya daldırmayın veya bulaşık makinesine koymayın.

2.5 İlave işlevler

2.5.1 Sesi değiştirme

- ➔ Çalıştırın.
- ➔ Aynı anda +-tuşuna ve orta tuşa basın.
- Melodi (S: 1) veya bip sesi (S: 2) seçilebilir.

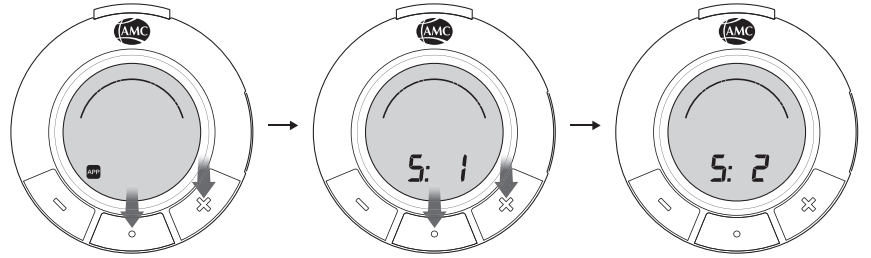

2.5.2 Görme engelliler için mod

Audiotherm görme engelliler için bir moda sahiptir (S: 0). Bu mod Audiotherm uygulamasıyla etkinleştirilebilir. Bu modda pişirme programlarını seçerken her pişirme programı için farklı bir ses dizisi çalar. Ayrıca „kademe arttırma“ (+) ve „kademe azaltma“ (-) sinyali farklıdır. Tüm diğer sinyaller „bip sesine“ eşdeğerdir (S: 2).

2.5.3 Yazılımı ve donanımı görüntüleme

➔ Aynı anda **+**-tuşuna ve orta tuşa basın ve tutun.

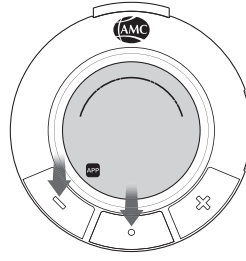

▪ Tüm ekran simgeleri kısa süre gösterildikten sonra yazılım numarası (örn. 012) ve ardından donanım numarası (örn. H01) belirir.

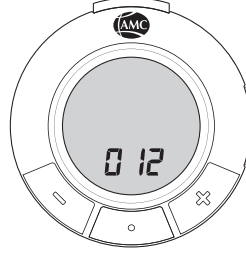

3. Ne yapmalı...

...Kullanılan Visiotherm'de mevcut olmayan bir pişirme programı seçildiğinde ne yapmalı?

Audiotherm yerleştirildiğinde bir hata sesi duyulur ve önceden seçilen pişirme programı ekrandan silinir.

➔ Hangi programda pişirileceğini kontrol edin.

...Bir programa ayarlanan Audiotherm'in Visiotherm ile iletişimi kesildiğinde ne yapmalı?

Bir hata sesi duyulur.

➔ Audiotherm'in tekrar doğru şekilde Visiotherm'e yerleştirin.

...Aşağıdaki hata mesajları belirdiğinde ne yapmalı?

E: 01

Audiotherm donanımında hata.

➔ Müşteri hizmetleriyle irtibata geçin.

E: 02

➔ Tüm bileşenlerin doğru yerleştirilip yerleştirilmediğini kontrol edin ve pişirme işlemi yeniden başlatın.

E: 03

➔ Audiotherm'i kapatın. Muhtemel manyetik parazit kaynaklarını çevreden uzaklaştırın.
➔ Audiotherm'i çalıştırın ve pişirme işlemi yeniden başlatın.
➔ Hata sürekli ortaya çıkıyorsa, müşteri hizmetleriyle irtibata geçin.

E: 04

Navigenio donanımında hata.

➔ Müşteri hizmetleriyle irtibata geçin.

4. Bakım ve temizlik

- Audiotherm sadece biraz durulama suyuyla ıslatılmış bir bezle silin.
- İşlevselliğini ve güvenliğini sağlamak için Audiotherm'in bakımını ve temizliğini düzenli olarak yapın.
- Audiotherm eğer suya düşerse:
 - ➔ Audiotherm'i hemen kapatın. Pil gözünü açın, pilleri çıkarın, görülebilen suyu bir bezle kurutun. Açılan Audiotherm'i ve pil gözünü en az 2 gün kurumaya bırakın.



5. Audiotherm ve uygulama

Audiotherm bir uygulama üzerinden kullanılabilir.

6. Elden çıkarma



Ambalaj, Audiotherm ve Visiotherm ev çöpüne atılmamalıdır. Materyaller yeniden değerlendirilebilir. Çevreye ve ilgili yerel kurallara göre uygun toplama yerlerinde bertaraf edin.

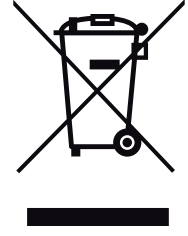

7. Teknik veriler

- 1,5V pil ebat AAA/LR03/Micro (örn. alkalin)
- Aynı ebatta yeniden şarj edilebilir 1,2V piller (örn. NiMH)



8. Uygunluk beyanı

Audiotherm, Avrupa Telsiz Cihazları Yönetmeliği 2014/53/AB uyarınca CE gerekliliklerini yerine getirmektedir. Eksiksiz uygunluk beyanını aşağıda „AMC Müşteri Hizmetleri“ bölümünde belirtilen adreste bulabilirsiniz.

9. AMC müşteri hizmetleri

Sorularınız veya önerileriniz varsa, lütfen AMC Müşteri Hizmetleriyle iletişime geçin.

Müşteri Hizmetleri

AMC Deutschland
Kundenservice
55408 Bingen

+49 (0) 6721-180 01

AMC Deutschland

Alfa Metalcraft Corporation
Handelsgesellschaft mbH
55408 Bingen
Deutschland
T: +49 6721 - 180 01

de@amc.info
www.amc.info



AMC Deutschland



amcdeutschland_bingen

AMC Italia

Alfa Metalcraft Corp. S.p.A.
Via Curiel 242
20089 Rozzano (MI)
Italia
T: +39 02 57 548 1

it@amc.info
www.amc.info



AMC Italia



amc_italia

AMC España

Alfa Metalcraft Corp. S.A.
Avenida Alcalde Barnils 64-68, bloque A, pta. 1ª
08174 Sant Cugat del Vallés
España
T: +34 93 653 53 70

es@amc.info
www.amc.info



AMC Espana



amc_espana



AMC Espana

AMC Österreich

Alfa Metalcraft Corporation
Handelsgesellschaft mbH
Handelskai 388/Top 222
1020 Wien/Österreich
T: +43 1 - 258 26 18 0

at@amc.info
www.amc.info



AMC Österreich

AMC Schweiz

Alfa Metalcraft AG
Buonaserstrasse 30
6343 Rotkreuz
Schweiz
T: +41 41 - 799 51 11

ch@amc.info
www.amc.info



AMC Schweiz



amc_schweiz

AMC Belgium

Alfa Metalcraft Corporation S.A.
Kortrijkssteenweg 205 – B. 1
9830 Sint-Martens-Latem
Belgique
T: +32 9 250 93 60

be@amc.info
www.amc.info



AMC Belgium



amc_belgium

AMC Nederland

Alfa Metalcraft Corporation B.V.
Stadionlaan 167
5246 JT Rosmalen
Nederland
T: +31 73 631 25 30

nl@amc.info
www.amc.info



AMC Nederland



amc_nederland

AMC Hrvatska

AMC Alfa Metalcraft d.o.o.
Kreše Golika 3
10090 Zagreb
Hrvatska
T: +385 1 619 55 89

hr@amc.info
www.amc.info



AMC Hrvatska

AMC Slovenija

Alfa Metalcraft d.o.o.
Dunajska cesta 185
1000 Ljubljana
Slovenija
T: +386 1 519 03 34

si@amc.info
www.amc.info



AMC Slovenija



amc_slovenija

AMC na Slovensku

Orechový rad 6
821 05 Bratislava
Slovensko
T: +421 905 624 659
slovakia@amc.info

slovakia@amc.info
www.amc.info



AMC Slovensko

AMC International

Alfa Metalcraft Corporation AG
Buonaserstrasse 30
6343 Rotkreuz
Switzerland
T: +41 41 - 799 52 22

info@amc.info
www.amc.info



AMC International



AMC International



amc_international



10046121000120118301120